

Max load:	- lb	- kg
Volume:	.12 cord of 8 ft	.45 m ³
Area tip to tip:	2.00 ft ²	.19 m ²
Rotator lifting capacity:	25000 lb	11340 kg
Torque at relief pressure:	15720 lb-in	1776 Nm
	913 psi	63 bars
Weight:	850 lb	386 kg

Rotator	Maximum pressure: 4200 psi 290 bars	Recommended flow: 10 gpm 38 l/min
Rotator recommended flow will produce a maximum speed of 21 rpm		

Cylinder	Diameter	Recommended pressure	Pressure range	Flow range	Lock valves
Standard	3 " (76 mm)	3700 psi (255 bars)	3200 - 4200 psi (221-290 bars)	9 - 13 gpm (34-49 l/min.)	No

Grapple cylinder maximum flow will theoretically produce a complete grapple open/close cycle in 4 seconds.

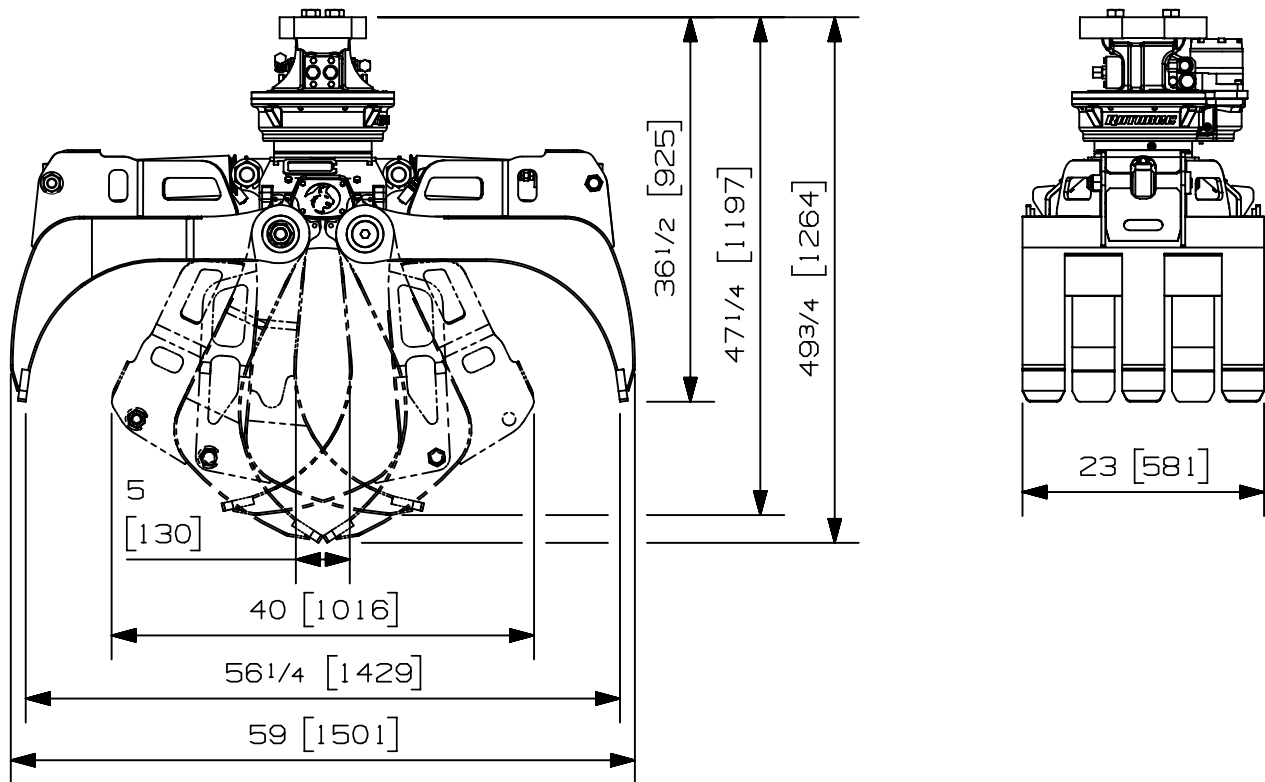

Options:

- See also RGP-252 Option for more options
-
-
-

web site: www.rotobec.com

email: rotobec@rotobec.com

Rotobec Inc.: Head office serving OEM's and Eastern Canada Ph: (418) 383-3002 Fax: (418) 383-5334
Rotobec West: Branch serving Western Canada and Western USA Ph: (250) 765-1161 Fax: (250) 765-0035
Rotobec USA: Branch serving Eastern and Central USA Ph: (603) 444-2103 Fax: (603) 444-0327

We reserve the right to change specifications and to improve our products without notice or obligation.

07011-2108
15/04/22 M.R.