



## Tugger

10,000lb(4,500kg) Towing Capacity

BWT45S-7



## Center Control Rider

6,500lb(3,000kg) Capacity

BWC33S-7



# About Doosan

## Values that drive our future growth



The Doosan Way is a unique set of corporate values and philosophy that has guided our growth. It is a systematic management philosophy for sustaining Doosan and raising our future competitive edge. The Doosan Way consists of two key parts: the Doosan Credo and a distinctive business system.

### **The Doosan Credo**

A resolute vision, the Doosan Credo unifies our employees worldwide, providing the direction in which we march together towards the future. Our shared aspiration is to be a global leader that provides world-class products and services that employees, customers, shareholders, and other stakeholders can trust and take pride in. The Doosan Credo places the highest importance on people, integrity, innovation, and delivering value to our customers and partners.

### **The Efficient Business System**

Our core business system is comprised of human resources, strategy execution, and financial management. Through this system, we implement our “2G Strategy” a manifestation of our conviction that our business can only grow through the growth of our people. It binds and systematizes our strategy with our people, multiplying business results. The Doosan business system supports the performance-oriented culture of Doosan and paves the way for continuous growth and development.

### **Cultivating People**

Doosan’s leadership course, Doosan Leadership Institute (DLI), strengthens job performance while teaching trainees the Doosan Way. The DLI is a space for learning and growth that realizes and continuously develops our philosophy of “People are the Future.” The purpose of the DLI is to create an organization that develops global leaders.

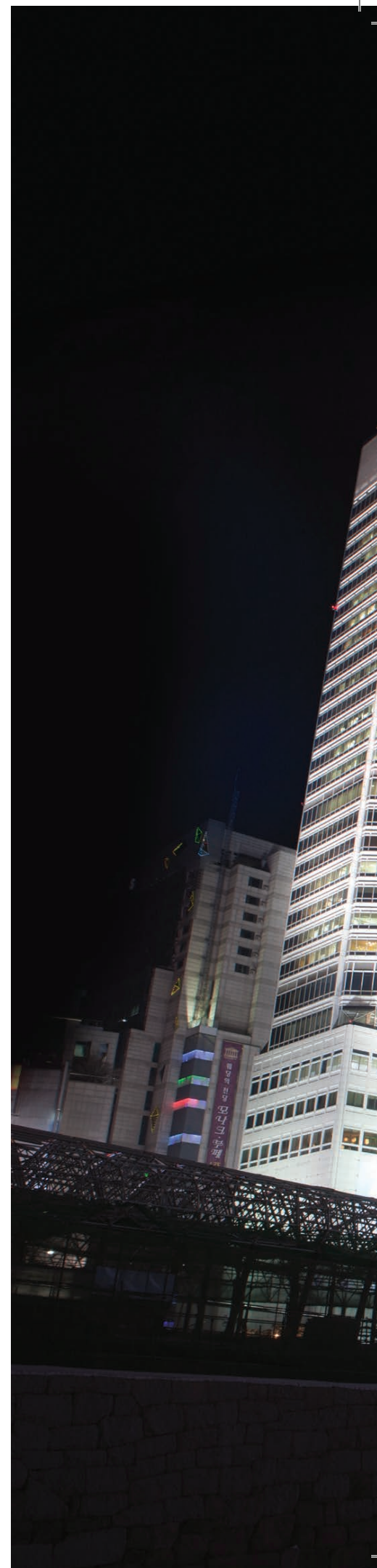



# Doosan Industrial Vehicle

Major global player in the infrastructure support business with a proud heritage

With a proud history dating back to 1937, when we first started out as Chosun Machinery, Doosan Industrial Vehicle has grown into Korea's largest machinery manufacturer, playing a leading role in the development of the industry in Korea.

Today, we are a global enterprise. We operate large-scale plants and sales subsidiaries both at home and overseas and maintain an operational network that spans continents.

#### **Committed To Innovation**

We remain committed to the advancement of new technologies and development of talented individuals, positioning us to respond effectively to the rapid changes taking place in the 21st century. Our mission is to strengthen our global position and become the industry leader well into the future.

#### **Committed To Our Customers**

We are committed to our customers, providing superior products and excellent services to go with them.

#### **Our Promise**

Doosan Industrial Vehicle will be the partner you can count on, always putting our commitment to you first.

#### **Award-Winning Machines**

Doosan currently holds a number of export, design & safety awards, including four Forklift Truck Association awards for Design Excellence.



## Gives You More 'Standard'

The BWT45S-7 Tugger features a 10,000 lb towing capacity to keep productivity moving. Doosan includes many standard features that are optional on competitive products.

- Power Steering is standard, making steering effortless and increasing productivity.
- An amber strobe light makes co-workers aware of the vehicle as it moves through the warehouse.
- AC Drive Control System for more operating efficiency and less maintenance.
- Battery rollers and dual side gates allow battery installation and removal from either side.
- A standard Hourmeter/BDI keeps track of the battery state of charge and run time.
- Operator safety and comfort are improved with a cushioned floor mat over a suspended floorboard that automatically applies the brake when the operator exits the vehicle.



### Total Picking Cycle

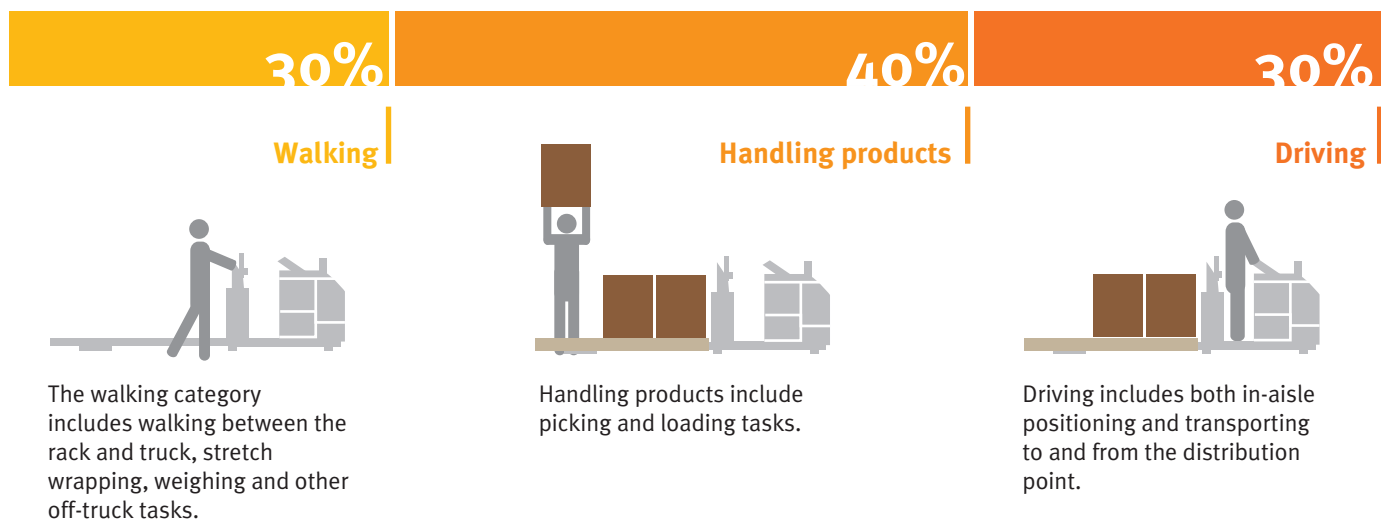



**BWC33S-7 CENTER CONTROL RIDER**

## Safety and Productivity

Doosan's BWC33S-7 Center Control Rider can make picking orders safer and more productive.

By placing the operator's compartment in the center of the truck, your operator is in a safer, more protected environment.

This center location also puts the load behind the operator during transport providing an unobstructed view in the forward direction.

The operator is in closer proximity to the pallet, saving steps and increasing pick speeds.

- Electronic power steering reduces fatigue and makes maneuvering in tight spaces much easier.
- The spring loaded floorboard absorbs shock and applies the brake when the operator exits on either side of the truck.
- Electronic Coast Control mode can be selected with a switch on the dash. Engaging Coast Control allows the truck to coast to a stop while the operator picks an item and places it on the pallet, performing a rapid, productive pick in one smooth motion.

The BWC33S-7 Center Control Rider can double as a transporter and a low level orderpicker, freeing up more expensive equipment.

### Technology That Works

Curtis solid state controllers provide smooth acceleration and seamless directional control. Its Regenerative Braking feature adds energy back to the battery to improve efficiency.



### Power and Performance

With AC Power, you will benefit from faster acceleration, more torque, higher efficiency, and lower maintenance costs due to the brush-less design.



### Real Time Information

Doosan powered warehouse vehicles come standard with an Hour Meter/Battery Discharge Indicator to keep track of hours used and reserve battery power at a glance.



GET **MORE** FOR YOUR MONEY

# Tugger **BWT**

## Ergonomic Handle

Reduces operator fatigue.

## Power Steering

Reduces steering effort by up to 90%.

## Hour Meter / BDI

Tugger comes standard with an Hour Meter/Battery Discharge Indicator to keep track of hours used and reserve battery power at a glance.

## Coast Control

Coast Control is an orderpicking mode that allows the truck to coast a short distance to position the pallet behind the operator when handling product.

## Stabilizing Caster

Helps to stabilize operator and load in turns and sudden stops.

## Dual Battery Entry/Exit Gates

For loading and unloading a replacement battery from either side.

## Magnetic Battery Storage Tray

Offers handy accessible storage for those must-have items that help get the job done.

## Flashing Light (Optional)

Alerts others to your presence.

## Storage Compartment

Handy compartment for out of the way storage.



## Low-Platform Step

0.04 in (250 mm)  
Eases entry and exit of vehicle.



## Operator Sensing Floorboard

Turns off truck and applies brake when operator exits truck.

## Suspended Floating Floorboard

Urethane cushion floorboard delivers superior comfort to the operator.



## Hitch (Option)

Eye Hitch

Pintle Hitch

Automatic Hitch



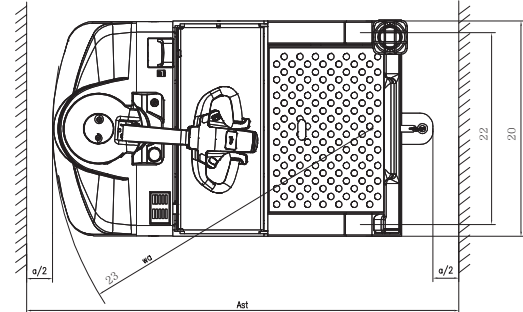
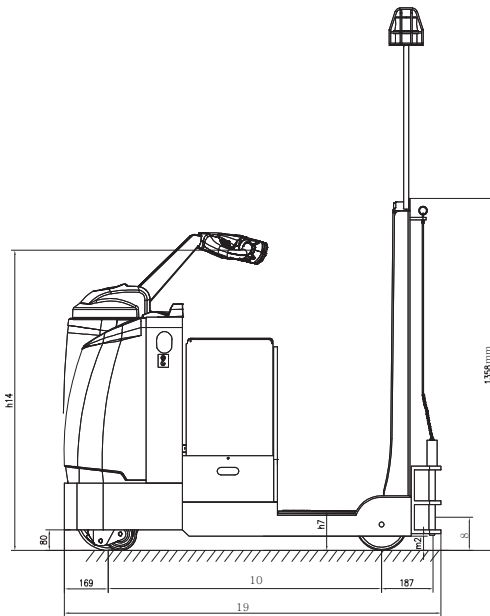

## Specification

Characteristics		
1 Model		BWT45S-7
2 Power type		Electric
3 Operator type		Standing
4 Towing capacity	lbs (kg)	9920 (4500)
5 Tire type (front/rear)	D/T	Polyurethane/Polyurethane
6 Wheels (x = driven)	F/R	1 x, 2/2
7 Rated traction weight(60 minutes rated)	lbs(kg)	242(110)
8 Drawbar center height	in (mm)	5(128)
9 Max.drawbar pull	lbs(kg)	661(300)
10 Wheelbase	in (mm)	41.5 (1054)
Weight		
11 Total service weight(with battery)	lbs (kg)	2204 (1000)
12 Axle loading: loaded (front/rear)	lbs (kg)	1278(580)
13 Axle loading: unloaded (front/rear)	lbs (kg)	926(420)
14 Battery weight	lbs (kg)	1232(559)
Chassis		
15 Tire compound		Polyurethane
16 Tire size (front)	in (mm)	10 x 3 (250 x 80)
17 Tire size (rear)	in (mm)	7.9 x 2 (200 x 50)
18 Additional wheels	in (mm)	5 x 2.4 (127 x 57)
Dimensions		
19 Overall length	in (mm)	56 (1422)
20 Overall width	in (mm)	32.7 (830)
21 Ground clearance	in (mm)	2 (55)
22 Aisle width	in (mm)	65.7 (1670)
Performance		
23 Turning radius	in (mm)	48.6 (1235)
24 Service brake		Electro-Magnetic
25 Travel speed: loaded/unloaded	mph (kph)	5.6/8.7 (9/14)
26 Gradeability: loaded/unloaded	%	4/20
27 Drive motor capacity	kW	4
28 Battery voltage nominal capacity: K5	V/Ah	24/560
30 Battery compartment size (780 x 335 x 625)	in	30.7 x 13 x 24.6

\* Specifications and dimensions of vehicles may change without notice for quality improvement, and images shown in this catalog may differ with actual ones.

GET **MORE** FOR YOUR MONEY

# Center Control Rider

# BWC

## Ergonomic Handle

Reduces operator fatigue.

## Power Steering

Reduces steering effort by up to 90%.

## Hour Meter / BDI

Center control rider comes standard with an Hour Meter/Battery Discharge Indicator to keep track of hours used and reserve battery power at a glance.

## Coast Control

Coast Control is an orderpicking mode that allows the truck to coast a short distance to position the pallet behind the operator when handling product.

## Stabilizing Caster

Helps to stabilize operator and load in turns and sudden stops.

## Dual Battery Entry/Exit Gates

For loading and unloading a replacement battery from either side.

## Magnetic Battery Storage Tray

Offers handy accessible storage for those must-have items that help get the job done.

## Flashing Light (Optional)

Alerts other to your presence for safer operations.

## Lift/Lower Switches

Allows lift and lower function on either side while facing rearward to enter and exit pallet.



## Storage Compartment

Handy compartment for out of the way storage.



## Low-Platform Step

0.04 in (250 mm)  
Eases entry and exit of vehicle.



## Operator Sensing Floorboard

Turns off truck and applies brake when operator exits truck.

## Suspended Floating Floorboard

Urethane cushion floorboard delivers superior comfort to the operator.





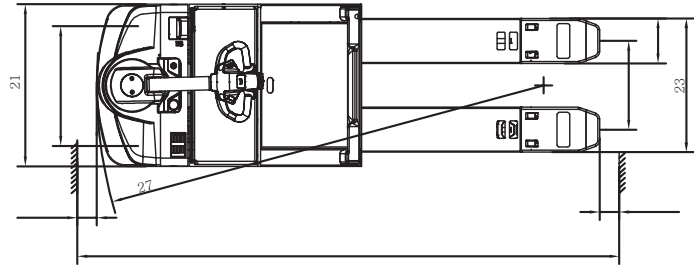
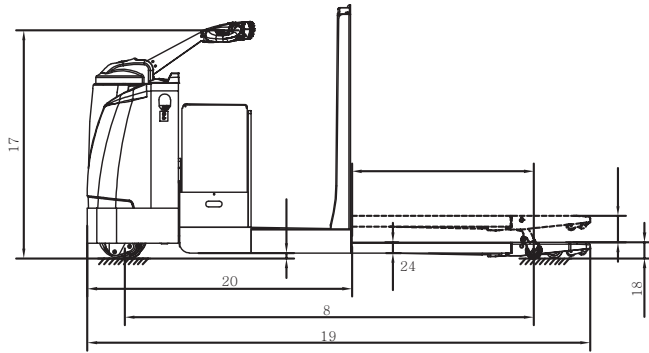

## Specification

Characteristics		
1	Model	BWC33S-7
2	Power type	Electric
3	Operator type	Standing
4	Load capacity	lbs (kg) 6600 (3000)
5	Tire type	D/L/C Polyurethane
6	Wheels (x = driven)	F/R 1 x, 2/2
7	Load center	in (mm) 24 (600)
8	Wheelbase	in (mm) 83.3 (2115)
Weight		
9	Total service weight	lbs (kg) 1984 (900)
10	Axle loading: loaded (front/rear)	lbs (kg) 2624/5975 (1190/2710)
11	Axle loading: unloaded (front/rear)	lbs (kg) 1455/529(660/240)
12	Battery weight	lbs (kg) 1232(559)
Chassis		
13	Tire compound	Polyurethane
14	Tire size (front)	in (mm) 10 x 3 (250 x 80)
15	Tire size (rear)	in (mm) 3.23 x 6.81 (82 x 173)
16	Additional wheels	in (mm) 5 x 2.4 (127 x 57)
Dimensions		
17	Height of control handle in drive position (min/max)	in (mm) 42/54 (1070/1370)
18	Lowered fork height	in (mm) 3.2 (82)
19	Overall length	in (mm) 101 (2570)
20	Length to face of forks	in (mm) 53 (1350)
21	Overall width	in (mm) 32.4 (823)
22	Fork dimensions	in (mm) 2 x 9 x 48 (55 x 230 x 1220)
23	Overall fork width	in (mm) 27(685)
24	Ground clearance	in (mm) 1 (27)
Performance		
25	Turning radius	in (mm) 90 (2290)
26	Service brake	Electro-Magnetic
27	Travel speed: loaded/unloaded	mph (kph) 3.6/3.7 (8/8.5)
28	Lift speed: loaded/unloaded	fps (mps) 0.08/0.1(0.025/0.035)
29	Lowering speed: loaded/unloaded	fps (mps) 0.1/0.1 (0.03/0.03)
30	Gradeability: loaded/unloaded	% 8/20
31	Drive motor capacity	kW 2.2
32	Lift motor capacity	kW 1.5
33	Battery voltage nominal capacity: K5	V/Ah 24/560
34	Battery compartment size (780 x 335 x 625)	in 30.7 x 13 x 24.6

\* Specifications and dimensions of vehicles may change without notice for quality improvement, and images shown in this catalog may differ with actual ones.

# Complementary Products

Doosan manufactures a wide range of quality products utilizing the latest technology and safety features.

Doosan's warehouse equipment provide excellent mobility and increased return on your investment over larger more expensive units.

Combined with our Electric, LPG, and Diesel powered forklifts, Doosan's warehouse products will bring efficiency to your operation, increasing your overall productivity.

## SITDOWN FORKLIFTS



**4-wheel LPG cushion tire**  
3,000 - 6,500lb capacity



**4-wheel, LPG/Diesel pneumatic tire**  
3,000 - 36,500lb capacity



**3-wheel, Electric cushion tire**  
2,500 - 4,000lb capacity



**4-wheel, Electric cushion tire**  
3,000 - 6,500lb capacity













## REACH TRUCKS



**Pantograph Reach Truck**  
3,500 - 4,000lb capacity



**Tugger**

Application Chart						
Transporting	 Hand Pallet Truck HPT	 Walkie Pallet Truck BW	 Rider Pallet Truck BWR	 Tugger BWT	 Center Control Rider BWC	 Electric Counterbalanced Truck 3-wheel Cushion 4-wheel Cushion
		 Walkie Stacker BWS	 Walkie Reach Stacker BWP	 Reach Truck BRP		
Storage / Stacking						
Personnel Transport				 Stock Chaser BSC	 Personnel Carrier BUV	 Burden Carrier BBC

## WAREHOUSE EQUIPMENT



Center Control Rider



**Hand Pallet Truck**  
5,500lb capacity



**Walkie Pallet Truck**  
4,500lb capacity



**Rider Pallet Truck**  
6,500lb capacity



**Walkie Stacker**  
3,300lb capacity



**Walkie Reach Stacker**  
3,300lb capacity



**Burden Carrier**  
4,400 - 5,500lb capacity



**Personnel Carrier**  
600lb capacity



**Stock Chaser**  
1,000lb capacity



**Doosan Corporation Industrial Vehicle**

Seoul Office  
 22/F, Doosan Tower, 18-12, Euljiro-6Ga,  
 Jung-Gu, Seoul, South Korea  
 Web site : [www.doosan-iv.com](http://www.doosan-iv.com)

**Doosan Industrial Vehicle America Corp.**

2475 Mill Center Parkway Suite 400  
 Buford, GA 30518 US  
 T: 888-323-9661  
 website: [www.doosanlift.com](http://www.doosanlift.com)

CCRTUGV1-14

AUTHORIZED DEALER