

Certain specification(s) are based on engineering calculations and are not actual measurements. Specification(s) are provided for comparison purposes only and are subject to change without notice. Specification(s) for your individual Doosan equipment will vary based on normal variations in design, manufacturing, operating conditions, and other factors. Pictures of Doosan units may show other than standard equipment.

# Powered by **Innovation**

**DOOSAN**

Doosan Infracore Co., Ltd.

489 Injung-ro, Dong-gu, Incheon, South Korea

<http://global.doosanequipment.com>

DIPBE-00-2108

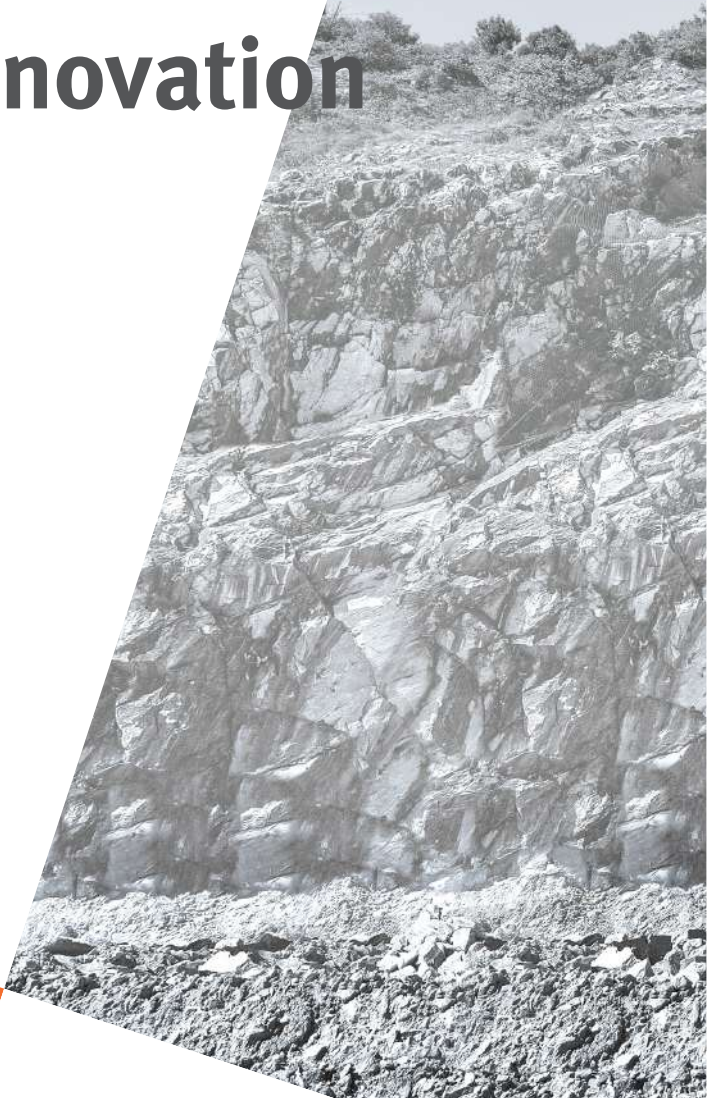



**DOOSAN**

Construction Equipment

# DX1000LC-7

**Engine Power**

T3 ISO 14396, Gross 470 kW (639.2 PS)@ 2,100 rpm  
SAE J1349, net 470 kW (639.2 PS)@ 2,100 rpm

T4F,S5 ISO 14396, Gross 469 kW (629 PS)@ 2,000 rpm  
SAE J1349, net 469 kW (629 PS)@ 2,000 rpm

**Operating Weight**

97,000 ~ 99,500 kg

**Bucket Capacity (SAE/PCSA)**

5.4 ~ 6.8 m<sup>3</sup>



Powered by Innovation



# DO BIG JOBS BETTER WITH STRONGER

## ***DX 1000LC***



The DX1000LC-7 is designed for maximum productivity with outstanding performance, durability and surprisingly high fuel efficiency. Serving as your reliable partner, it will enable you to work in harsh mining environments where avoiding downtime is critical.







# OVERVIEW OF DX1000LC-7

## HIGH PRODUCTIVITY AND LOW COST OF OWNERSHIP

Delivers higher productivity and reduced fuel consumption for efficient and comfortable work environment.

## ENGINE

Exceptionally powerful – with high torque at low revs – the Perkins 2806D (T3), 2806J (T4F/StageV) engine combines reliability and low environmental impact. This T4F, T3 and S5 compliant 6 cylinder engine delivers 470 kW @ 2,100rpm (T3), 469 kW @ 2,000rpm (T4F/StageV).

## RELIABILITY

Designed for the toughest applications and the most abrasive environment.

## SAFETY

Your safety is our priority: Optional Around View Monitoring (AVM) system, large side mirrors, Powerful LED work lights, anti-slip steps and platforms, guard rails on upper structure.

## MASS EXCAVATION

2 Heavy duty(HD) front combinations available to match various conditions. Mass excavation front with large bucket size or heavy-duty fronts when long reach is needed.

## SWING BEARINGS

Unique design of crossed bearing providing longer lifetime with lower stress distribution.





### EASY MAINTENANCE

Automatic greasing system as an option, all filters easily accessible, compressor with air gun as option, everything designed for easy maintenance.

### COMFORT

One of the most spacious cabs in the market, with low noise & vibration levels and excellent all-round visibility. Fully adjustable heated air-suspension seat, air conditioning with climate control as standard.

### UNDERCARRIAGE DURABILITY

Heavy-duty undercarriage, with large rollers and sprocket, enhanced frame for the toughest applications.

### EXCELLENT FUEL EFFICIENCY

The Smart Power Control (SPC) system increases fuel efficiency by adjusting the power to meet the application's needs.

### ADVANCED FILTRATION

High efficiency filters & cleaners remove water, dust & particles to protect your investment optimally.

### OPERATION AT EASE

All important information is at your fingertips with the new easy-to-use 8" touch screen. Exclusive jog shuttle switch, 4 work & 4 power modes, proportional control.





# PERFORMANCE AND PRODUCTIVITY

New and Intelligent Hydraulic System Deliver The Best-In-Class Productivity.



## ENGINE WITH ENHANCED POWER AND RELIABILITY

Manufactured in a world-class facility for reliability and durability, the DX1000LC-7 engine ensures many years of productive life to keep your machine running efficiently and effectively even under the toughest jobsite conditions. Along with this, it allows you to maintain your machine at a low cost throughout its lifetime with features that minimize service costs combined with low fluid consumption.



\* Actual product may differ from the image shown above.

## THE MOST ADVANCED HYDRAULIC SYSTEM (D-ECOPOWER+)

This new electronic main pump accurately calculates the amount of pump flow required for each actuator, thereby maximizing productivity (faster operation) and avoiding unnecessary fuel loss.

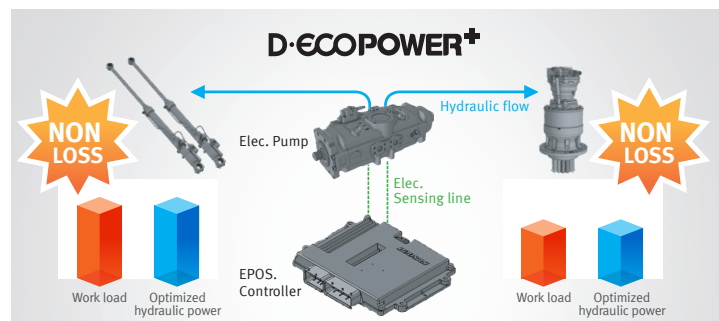





**18%**  
HIGHER  
PRODUCTIVITY

Internal test result vs. DX800LC  
(Maximum size bucket)

**EPOS CONTROLLER**

**MCV**

**MCV II**

**ADVANCED ELECTRONIC MAIN PUMP**

**SELECTABLE OPERATING MODES OPTIMIZED FOR VARIOUS WORK ENVIRONMENTS**

**Boom/Swing Priority Control**

Allows you to control operating modes with just one button and provides optimized level, resulting in a more comfortable and productive operation.

**BOOM PRIORITY MODE**

Hydraulic power

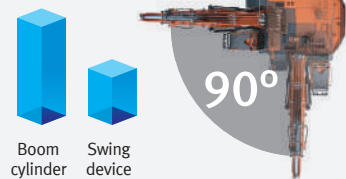

**SWING PRIORITY MODE**

Hydraulic power

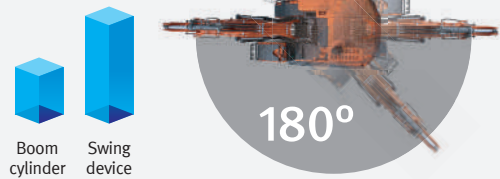

**EFFICIENT FUEL MANAGEMENT**

- Choice of 4 power modes and 4 working modes offers optimum performance in all conditions.
- Smart Power Control (SPC) system: provides optimal engine speed and pump torque according to work conditions. The system automatically adjusts engine power and hydraulic output to improve fuel efficiency and reduce emissions.
- Engine auto-shut-off: shuts down the engine after the machine has been idling for a specified time. The operator can set the delay before shut-off via the touchscreen.





# INCOMPARABLE DURABILITY

**Built With Quality-Proven Main Components And Durable Design For Minimized Downtime**

## QUALITY-PROVEN MAIN COMPONENTS

Manufactured with the finest quality main components customized precisely for large equipment, this new machine offers the Best-in-Class power and durability.



**A. SWING MOTOR**

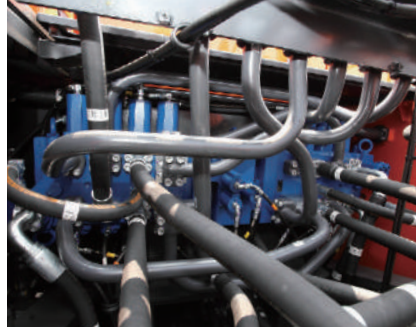

**B. MCV**

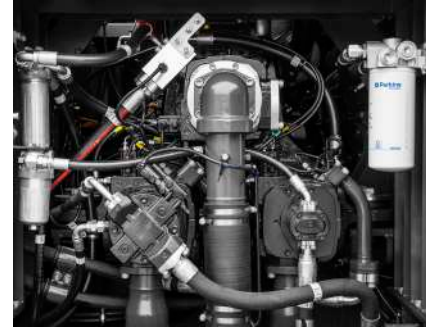

**C. MAIN PUMP**

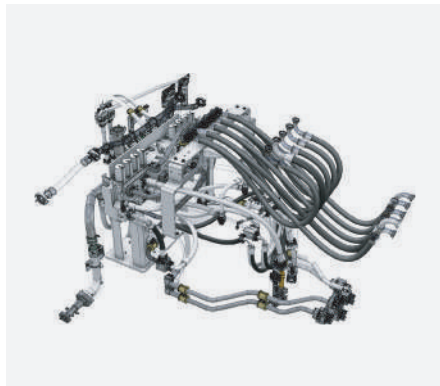

**PROTECTED HYDRAULIC SYSTEM**

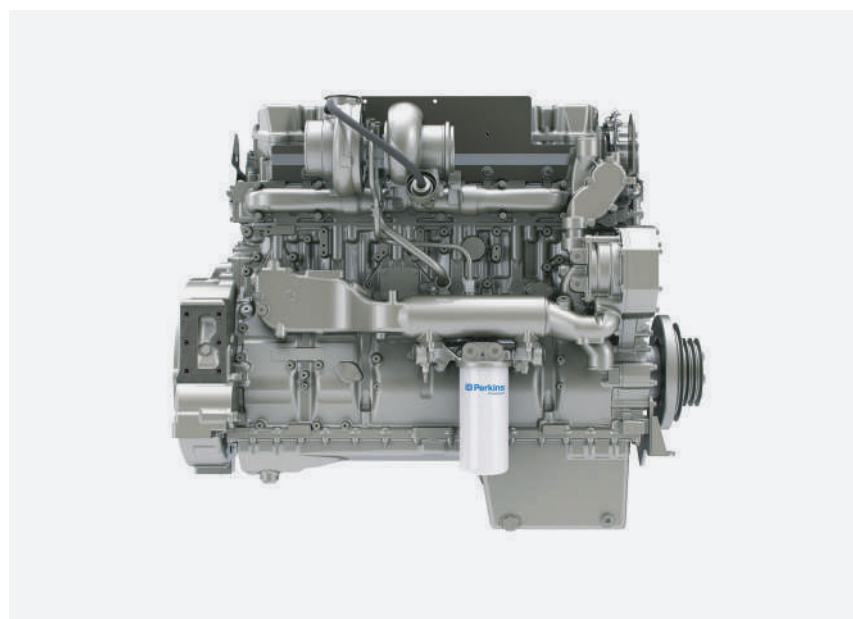

**D. ENGINE**

\* Actual product may differ from the image shown above.



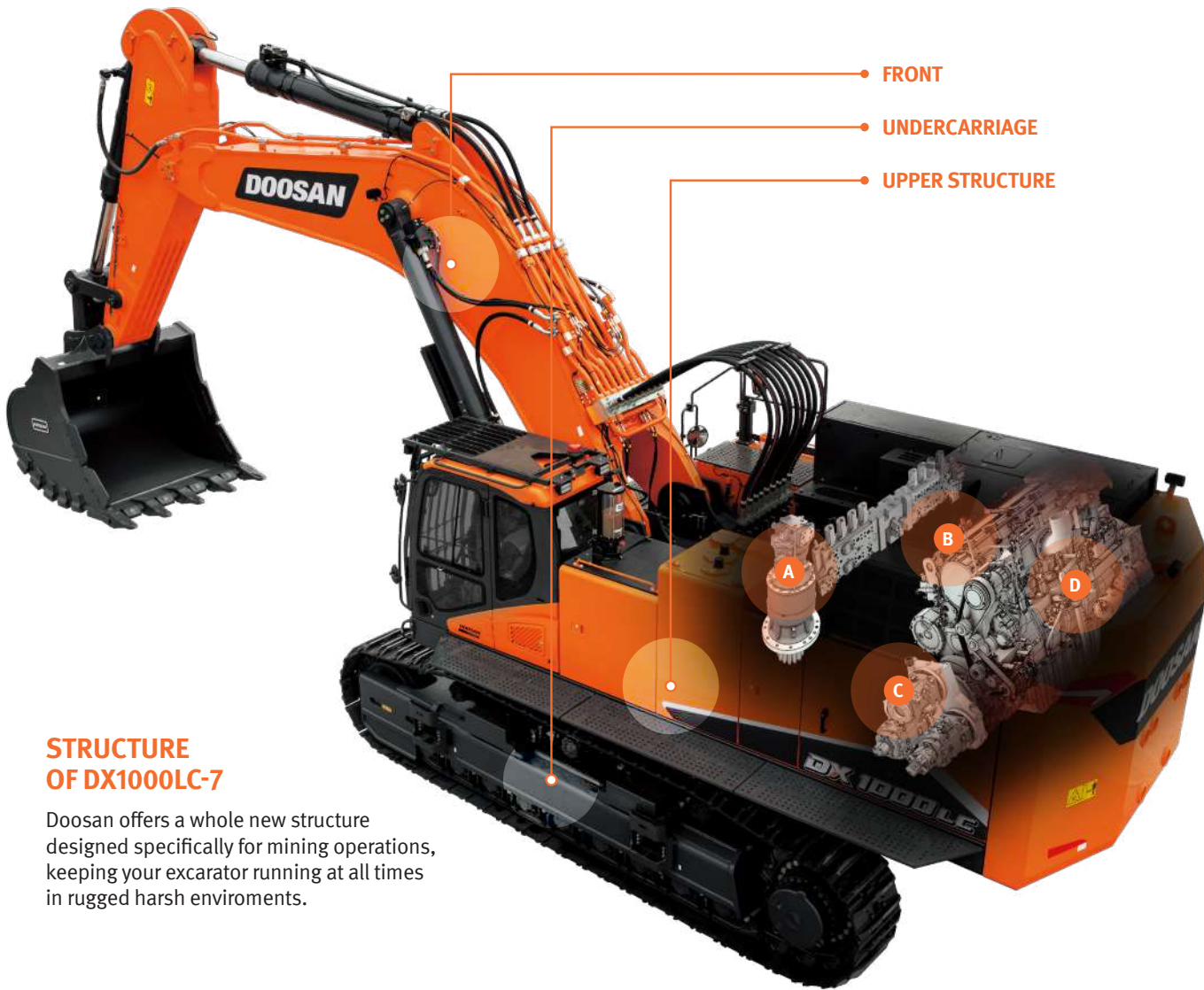

## STRUCTURE OF DX1000LC-7

Doosan offers a whole new structure designed specifically for mining operations, keeping your excavator running at all times in rugged harsh environments.

### HEAVY DUTY FRONT

Performance of the boom and arm of the DX1000LC-7 has considerably enhanced the overall durability of the machine.

#### BOOM

1. Boom foot design to increase the pin strength and decrease one-side wear of pin.
2. Flat steel plate for dispersing machine stress.
3. Welding design to increase welding part lifetime.
4. Inner reinforce plate changed for dispersing stress.

#### ARM

5. Bottom steel plate of arm to increase strength of arm structure.
6. Arm center boss to lower stress.
7. Arm welding design to decrease stress.
8. Diameter of pin (130 ▶ 140) to increase pin strength.

### UPPER STRUCTURE



9. HEAVY DUTY UNDER COVER



10. CROSSED ROLLER SWING BEARINGS  
Unique design of crossed bearing providing longer lifetime with lower stress distribution.

### UNDERCARRIAGE



11. FRAME

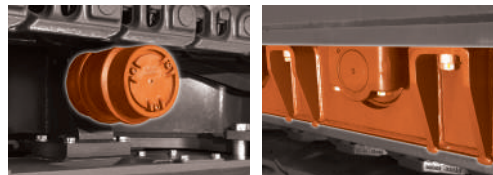

12. UNDERCARRIAGE  
Our heavy duty undercarriage further increases durability of your machine.

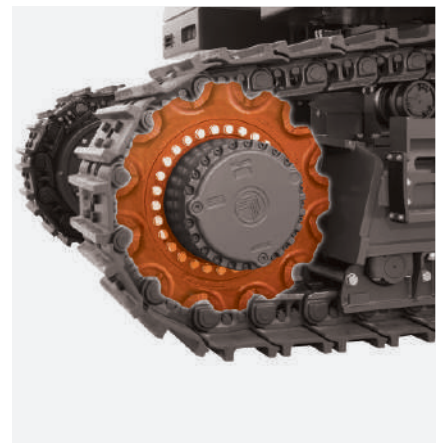

13. HEAVY-DUTY SPROCKET  
Our heavy duty sprocket further increases durability of your machine.



# COMFORT AND SAFETY

Safety Comes In First With Enhanced Safety Features



\* Actual product may differ from the image shown above.



### LED WORKING LAMP

More productive at night with highly improved sight.



### AROUND VIEW MONITOR (AVM) SYSTEM

Provides 360-degree view in your cabin through AVM system.



### 8" TOUCH SCREEN

An easy to read and use 8" touch screen integrated all function in one place

### DOOSAN SMART KEY

We bring automotive standard and comfort to construction machinery

- Search function
- Coming/leaving home light function
- Remote door opening
- Keyless engine start



### ERGONOMICALLY DESIGNED PEDAL

Ergonomically designed travel pedals placed in the middle. Pedal angle adjusted to relieve the pressure on ankle and joints, reducing fatigue and to lessen the load of operator.





# EASY MAINTENANCE



## AIR COMPRESSOR

Air gun in your cabin helps you to keep clean and comfortable ambience.

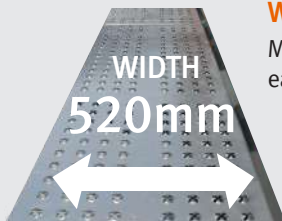

## WIDE CATWALK

Maintenance is made easier with 520mm catwalk.

\* Actual product may differ from the image shown above.



# We Offer Easy, Breezy Maintenance System That Can Also Prevent Downtime Of Your Machine.

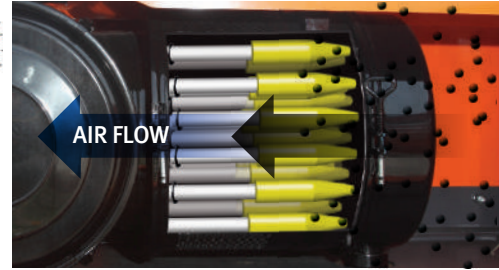
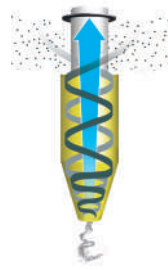

## HEAVY DUTY AIR CLEANER

Protects from dust and contaminated particles with a two-stage air cleaner, enabling easy maintenance and downtime avoidance.

## REVERSIBLE FAN

- Rotating cooling fan in reverse direction is possible.
- Able to blow away dust on radiator and oil cooler easily to save time & effort.

## AUTO GREASE SYSTEM (AGS)

This new auto grease filling device helps reduce maintenance time significantly and avoid unexpected downtime.

## ELECTRIC FUEL TRANSFER PUMP (ETP)

Use this switch to easily refill fuel for your machine after its inspection or repair.

## CENTRALIZED FUEL FILTRATION SYSTEM

Water separator, pre-fuel filter and main filter are grouped together to increase engine life and prevent machine failures, making machine inspection or maintenance much easier with one simple access.





# TELEMATICS SERVICE (OPTIONAL)

## TELECOMMUNICATIONS Data flow from machine to web



### TELEMATICS SERVICE TERMINAL

Telematics Service terminal is installed to machine / connected to EPOS™



### TELECOMMUNICATION

GPS, EPOS™ data is sent to designated server by GSM, Satellite telecommunication



### DOOSAN TELEMATICS SERVICE WEB

Doosan, Dealer, Customer can easily monitor the GPS, EPOS™ data from Core Telematics Service web

## TELEMATICS SERVICE BENEFITS Doosan and dealer support customers to improve work efficiency with timely and responsive services

### CUSTOMER

Improve work efficiency

- Timely and preventive service
- Improve operator's skills by comparing work pattern
- Manage fleet more effectively

### DEALER

Better service for customers

- Provide better quality of service
- Maintain machine value
- Better understanding of market needs

### DOOSAN

Responsive to customer's voice

- Utilize quality-related field data
- Apply customer's usage profile to developing new machine

## FUNCTIONS(WEB/APP) Doosan Telematics Service provides various functions to support your great performance



- GPS



- Fuel information



- Preventive maintenance



- Operation hours



- Fault code/warning



- ADT Productivity

Equipment ID	Model	Serial No.	Location	Category	Usage	Health
1000000001	EX200LC-7	1000000001	Site A	Excavator	100%	Good
1000000002	WL200	1000000002	Site B	Wheel Loader	95%	Good
1000000003	ADT200	1000000003	Site C	ADT	80%	Warning

- Reports

FUNCTION	EXCAVATOR	WHEEL LOADER	ADT
GPS	All models	All models	All models
Operation hours	All models	All models	All models
Operation hours	All models Tier 4 only	All models	All models
Maintenance parts	All models	Tier 4 only	All models
Fault code/ Warning	All models	Tier 4 only	All models
Fuel information	All models Tier 4 only	Tier 4 only	All models
Dump capacity	N/A	N/A	All models



# GLOBAL PARTS NETWORK

## QUALITY-PROVEN MAIN COMPONENTS

Doosan provides fast and precise worldwide delivery of genuine Doosan parts through its global PDC (parts distribution center) network.



## GLOBAL NETWORK

The global network of the GPDC (Global Parts Distribution Center) maximizes its supply rate by making sure that each center is stockpiled with all the critical parts required for businesses in its area. The network also minimizes the time and costs required for parts delivery by positioning PDCs close to major markets around the world. Doosan PDCs communicate with customers in their time zone, informing them that they are open for operation, and deliver parts to them as early as possible.

## THE GLOBAL PARTS DISTRIBUTION CENTER NETWORK

PDCs had been set up as shown below, including Mother PDC in Ansan, Korea. The nine other PDCs include one in China (Yantai), Four in USA (Seattle and Atlanta, Suwanee, Miami), two in Europe (Germany and the UK), one in the Middle East (Dubai) and one in Asia (Singapore).



## PDC BENEFIT

-  **Distribution Cost Reduction**
-  **Maximum Parts supply rate**
-  **Shortest distance/ time parts delivery**
-  **Real-time service support**
-  **Minimum downtime**



# ATTACHMENTS

## S CLASS (SEVERE DUTY) BUCKET

S CLASS BUCKET is designed for mass excavation in high density severe mining & quarry using high strength and abrasion resistance materials.



- High strength steel
- High abrasion resistant steel

### Feature & Benefits

- 2 different size are available
- Diamond folded section for greater structural strength.
- Overlapping plate for protecting lip plate and increasing strength.
- Optimized shape for high penetration and heel clearance.
- Deep profile for high capacity.
- Low tip radius for greater digging performance.
- Optimized design for genuine Doosan SD (Severe Duty) tooth for durability and productivity.
- Bolt-on dual side shroud design for more durability and protection in severe application.
- Wear pads and bottom section.
- High grade material composition for better durability.
- Used incredible strength with lip plate using 500HBN.
- Used higher abrasion resistance using 400HBN.

Classification	Model name	Width(mm)	Capacity(m <sup>3</sup> )	Lip plate(mm)
DX1000LC-7	BUCKET ASSY;5.4m <sup>3</sup>	1,940	5.4	70
	BUCKET ASSY;6.8m <sup>3</sup>	2,320	6.8	70



## HYDRAULIC BREAKER

Designed for mainly focusing on breaking job. Doosan's focus is to optimize impact power, enhance durability, satisfy customer convenience and maintain easily in order to be faithful to the original function of hydraulic breaker.



### Feature & Benefits

- Concrete proven working principle (Oil and gas assist)
- Anti-blank blow system
- Dual Speed Control
- Competitive component counts
- Heavy duty main bracket design
- Maximized life time of dampers and wear plate
- Centralized lubricating System (option)

Model name	Operating Weight(Kg)	Tool Diameter(mm)	Operating pressure(bar)	Flow(l/min.)		Frequency	
				Min.	Max.	High BPM	Low BPM
DXB1000	10,070	245	165-185	410	530	360-470	360-470



# SPECIAL APPLICATION

Doosan provide various solution & various custom job application.

## SUPER LONG REACH (SLR FRONT)

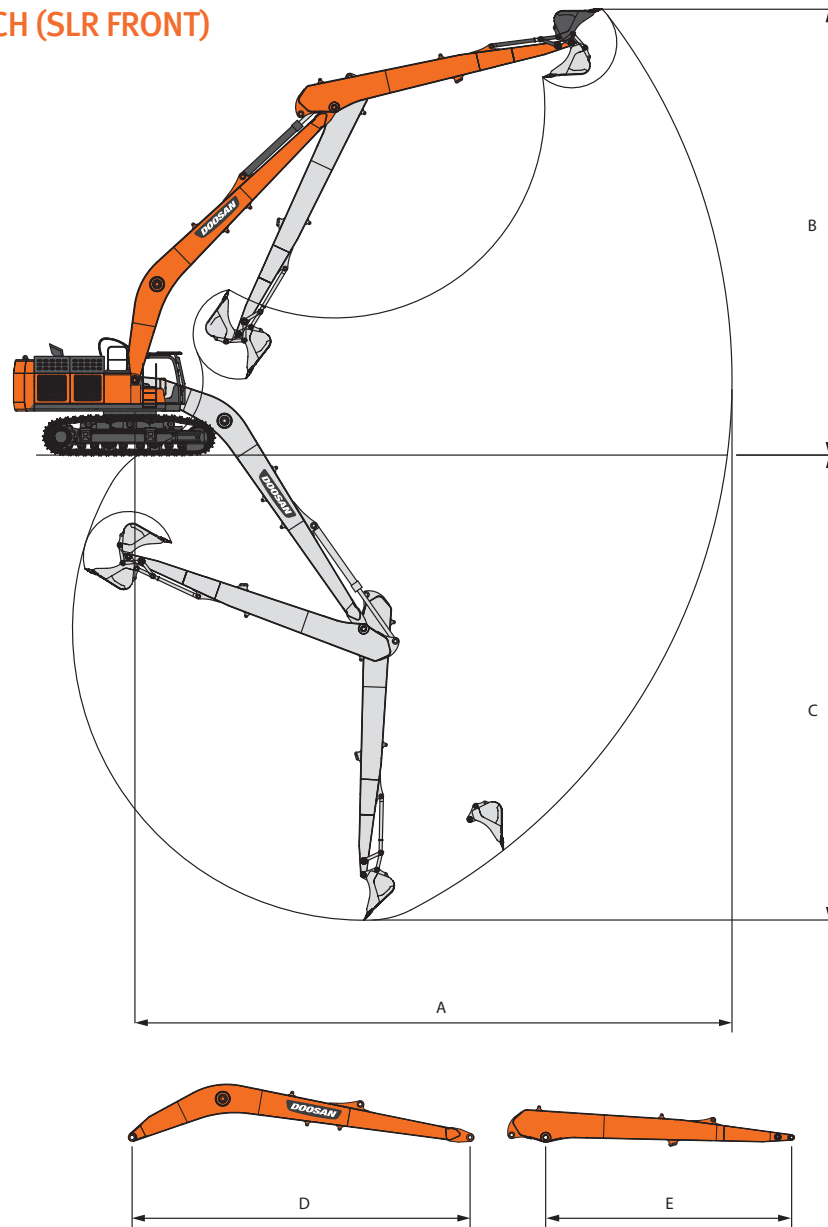

## SUPER LONG REACH (SLR FRONT)

Max. Digging Reach	(mm)	A	27,010
Max. Digging Height	(mm)	B	18,590
Max. Digging Depth	(mm)	C	21,600
Boom Length	(mm)	D	15,800
Arm Length	(mm)	E	11,600
Bucket Capacity (SAE/PCSA)	(m <sup>3</sup> )	-	0.98
Additional Counterweight	(kg)	-	5,000

## MATERIAL HANDLER

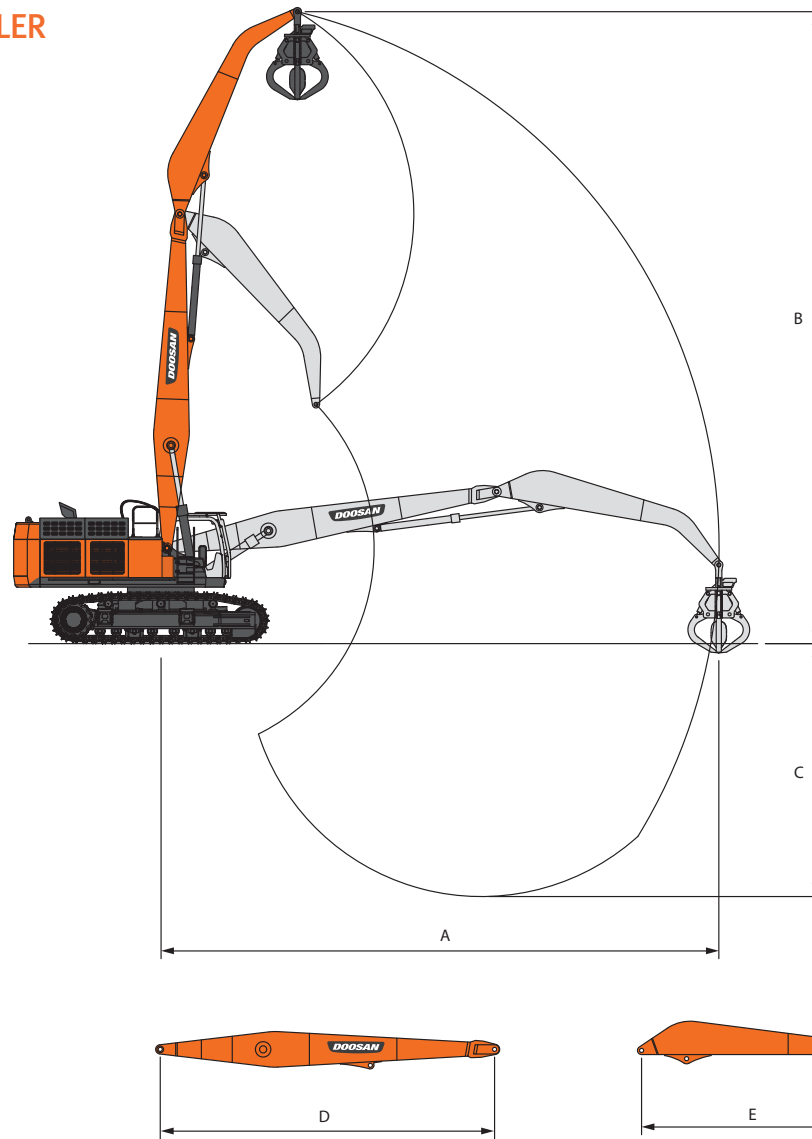

## WORKING RANGES

Max. Arm End Reach	(mm)	A	18,230
Max. Arm End Height	(mm)	B	19,680
Max. Arm End Depth	(mm)	C	8,160
Boom Length	(mm)	D	10,900
Arm Length	(mm)	E	8,000
Additional Counterweight	(kg)	-	5,000

## MATERIAL HANDLER ATTACHMENTS

Model		Orange Grapple	
		OG60	
Capacity	(m <sup>3</sup> )	0.97	



### Orange Grapple

is commonly designed for handling scrap iron in wrecking yards or recycling plants and waste in landfill sites. Sometime it also used in building sites for transferring stones.



# SPECIAL APPLICATION

Doosan provide various solution & various custom job application.

## HIGH REACH DEMOLITION

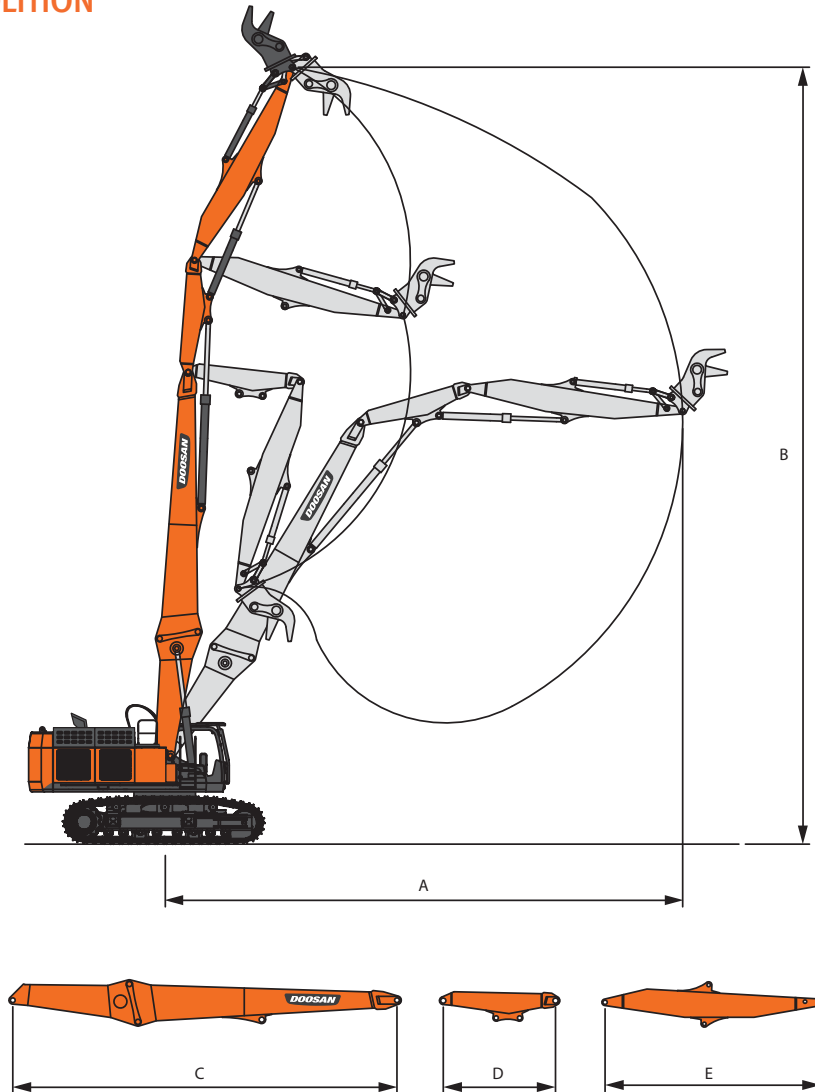

## WORKING RANGES

Max. Arm End Reach	(mm)	A	22,000
Max. Arm End Height	(mm)	B	36,010
Max. Arm End Depth	(mm)	C	18,400
Boom Length	(mm)	D	2,800
Arm Length	(mm)	E	12,200



## DEMOLITION ATTACHMENTS

Model	Rotating Crusher	Multi-Processor
	RC34	MP34
Crushing Force	78	101
Opening Width	1,056	980

### Rotating Crusher

is designed for both primary demolition work and secondary concrete reduction. Especially for secondary demolition, it is ideal for breaking out concrete from fixed structure, pulverizing concrete, materials for recycling, cutting reinforced rods and small separating different steel profile, and working with high reach boom.

### Multi-Processor

is designed for all demolition sites by inter-changing jaw sets mounted on a single base unit.

## FRONT SHOVEL

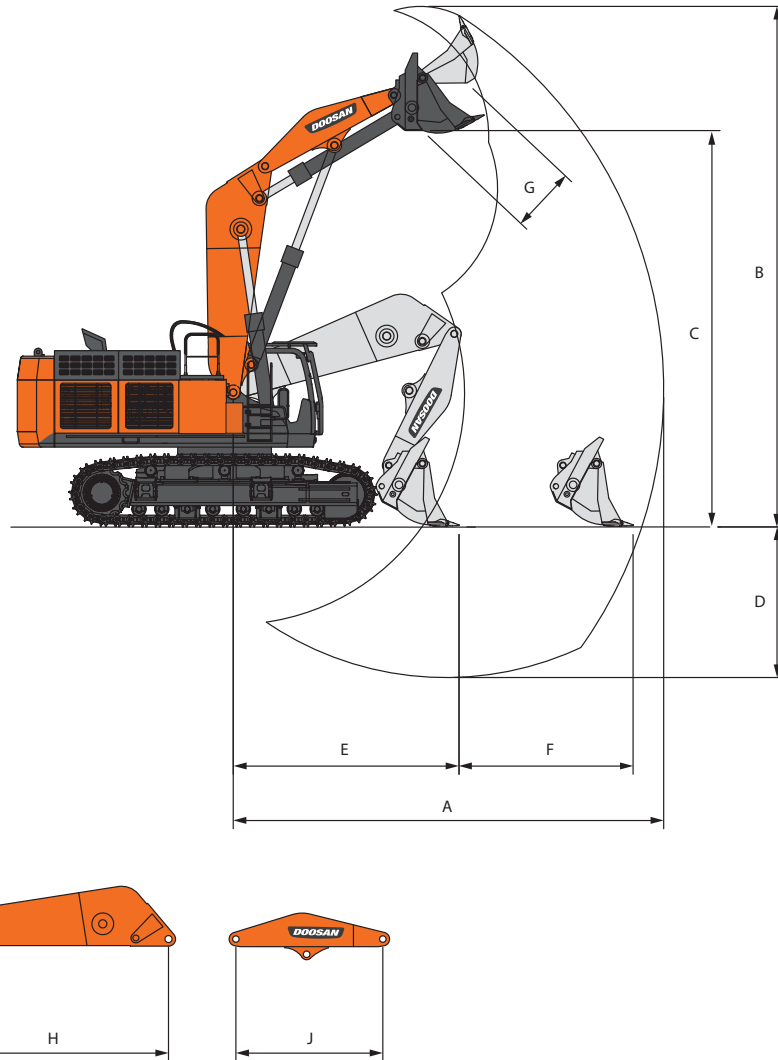

## WORKING RANGES

Max. Digging Reach	(mm)	A	15,500
Max. Digging Height	(mm)	B	12,180
Max. Dumping Height	(mm)	C	8,500
Max. Digging Depth	(mm)	D	4,900
Min. Digging Reach	(mm)	E	6,890
Digging Range On Ground	(mm)	F	3,660
Bucket Capacity(SAE/PCSA)	(m <sup>3</sup> )	G	5.5
Boom Length	(mm)	H	5,100
Arm Length	(mm)	J	3,200

## OPTIMIZED SHOVEL BUCKET

### Features & Benefits

Spill guard is applied to load more capacity.

High Grade material composition for better durability.

- Added more patches for durability and strength on lip plate and inner shell.

- Muscle pack heels to increase durability and protect shell from wear.

### Bottom Dump bucket

■	HBN (Best Plate)
■	HBN500
■	HBN400
■	CASTING

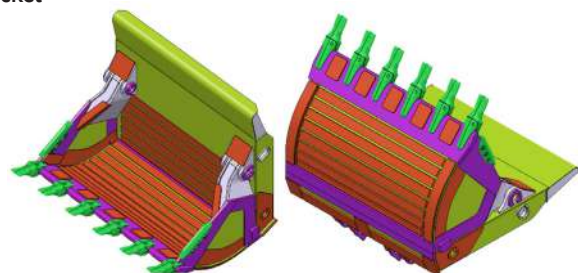



# TECHNICAL SPECIFICATION

## ENGINE

### Model

Perkins 2806D (T3)  
Perkins 2806J (T4F,S5)

### Type

Turbocharged after WATER-COOLED  
MEUI (Mechanically Actuated Electronically Controlled Unit Injector)

### Number of cylinders

6

### RATED HORSE POWER

470 kW (639 PS) @ 2,100rpm (ISO14396, Gross) (T3)  
469 kW (629 PS) @ 2,000rpm (ISO14396, Gross) (T4F,S5)

### Max torque

282.4 kgf.m @ 1,400 rpm (T3)  
301.1 kgf.m @ 1,300 rpm (T4F,S5)

### Piston displacement

18.1 l

### Bore & stroke

∅ 145 mm x 183 mm

### STARTING MOTOR

24 V x 9.0 kW

### batteries

24 V (12 V X 2 / 200 AH)

### Air cleaner

Double element with precleaner

## HYDRAULIC SYSTEM

The heart of the system is the EPOSTM (Electronic Power Optimizing System). It allows the efficiency of the system to be optimized for all working conditions and minimizes fuel consumption. The new EPOSTM is connected to the engine electronic control via a data transfer link to harmonize the operation of the engine and hydraulics.

- The hydraulic system enables independent or combined operations.
- Two travel speeds offer either increased torque or high speed tracking.
- Cross-sensing pump system for fuel savings.
- Auto deceleration system.
- Two operating modes, two power modes.
- Button control of flow in auxiliary equipment circuits.
- Computer-aided pump power control.

### Main pumps

Tandem, Axial piston  
max flow : 3 X 523 l/min @ 100 bar, 1,800 rpm  
Displacement : 280 X 3 cc/rev

### Pilot pump

Gear pump - max flow : 60 l/min  
Pilot pump : 32 cc/rev

### Main relief Pressure

Main Relief Valve Pressure : 360 bar (367 kgf/cm<sup>2</sup>)  
Travel Crossover Relief Valve Pressure : 368 bar (375 kgf/cm<sup>2</sup>)  
Swing Crossover Relief Valve Pressure : 294 bar (300 kgf/cm<sup>2</sup>)

## WEIGHT

Shoe Width	Ground Pressure	Machine Weight
STD. 650DG mm	1.37 kgf/cm <sup>2</sup>	97.0 ton
OPT. 750DG mm	1.19 kgf/cm <sup>2</sup>	97.6 ton
OPT. 750DG mm	1.20 kgf/cm <sup>2</sup>	98.3 ton
OPT. 900DG mm	1.01 kgf/cm <sup>2</sup>	99.5 ton

## BUCKET

Bucket Type	Capacity (m <sup>3</sup> )	Width (mm)	
	SAE/PCSA	W / O Cutter	With Cutter
S Class	5.4	1,940	1,940
	6.8	2,320	2,320

Based on ISO 10567 and SAE J296, arm length without quick change clamp

## HYDRAULIC CYLINDERS

The piston rods and cylinder bodies are made of high-strength steel. A shock absorbing mechanism is fitted in all cylinders to ensure shock-free operation and extend piston life.

Cylinders	Quantity	Bore x Rod diameter x stroke
Boom	2	215 X 150 X 1,905 mm
Arm	1	240 X 170 X 2,020 mm
Bucket	1	210 X 145 X 1,530 mm

## UNDERCARRIAGE

Chassis are of very robust construction, all welded structures are designed to limit stresses. High-quality material used for durability. Lateral chassis welded and rigidly attached to the undercarriage. Track rollers lubricated for life, idlers and sprockets fitted with floating seals. Tracks shoes made of induction-hardened alloy with triple grousers. Heat-treated connecting pins. Hydraulic track adjuster with shock-absorbing tension mechanism.

Upper rollers - 3  
 Lower rollers - 9  
 Track shoes - 51  
 Overall track length - 6,370mm

## SWING MECHANISM

High-torque, axial piston motor with planetary reduction gear bathed in oil. Swing circle is singlerow, shear type ball bearing with induction-hardened internal gear. Internal gear and pinion gear immersed in lubricant.

Max. Swing speed - 6.3 rpm  
 Max. Swing speed - 6.1 rpm  
 Max. Swing Torque - 39,330 kgf.m (386 kN.m)  
 Max. Swing Torque - 31,850 kgf.m (312 kN.m)

## DRIVE

Each track is driven by an independent, high-torque, axial piston motor through planetary reduction gear. Two levers or foot pedal control provide smooth travel or counter-rotation upon demand.

Travel speed (High / low) - 4.5 / 2.6 km/h  
 Maximum traction force - 60.6 / 36.9 ton  
 Grade ability - 70%

## REFILL CAPACITIES

Fuel tank - 1100 l  
 Cooling system - 99.8 l  
 Engine oil - 65 l  
 Swing drive - 2 X 8 l  
 Final drive - 2 X 25 l  
 Hydraulic tank - 880 l

## BUCKET DIGGING FORCES

Bucket Type	Capacity (m <sup>3</sup> )	Width (mm)		Digging force (ton)
	SAE/PCSA	W / O Cutter	With Cutter	
S Class	5.4	1,940	1,940	STD/OPT [SAE] 40 / 44.8 [ISO] 42.96 / 48.2
	6.8	2,320	2,320	

## ARM DIGGING FORCES

Arm	Length	Weight	Digging force (ton)
Standard	3,750 mm	3,563 kg	[SAE] 36.22, [ISO] 36.73
Short	2,900 mm	3,283 kg	[SAE] 40.3, [ISO] 40.8



# DIMENSION

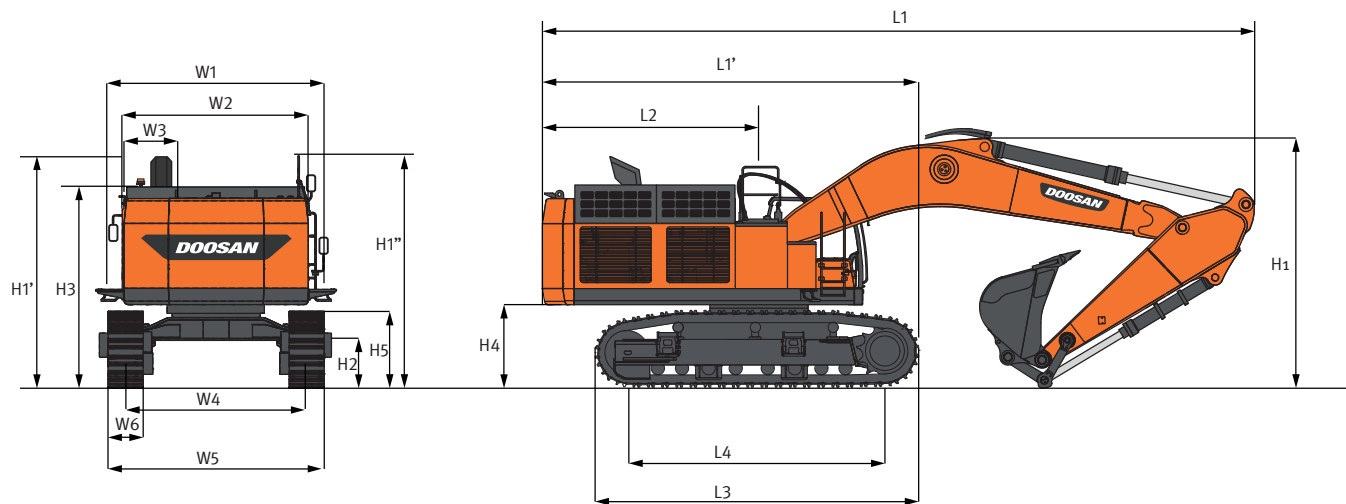

## DIMENSIONS

BOOM TYPE(ONE PIECE)			mm	7,250	8,400
ARM TYPE			mm	2,900	3,750
BUCKET TYPE			m <sup>3</sup>	6.8	5.4
Under Carriage(Grouser)				650DG	650DG
L1	Overall Length		mm	13,800	14,550
H1	Overall Height	Boom	mm	5,090	5,450
		Hose	mm	5,150	5,550
		Cabin	mm	3,615	
		Hand/Guard Rail	mm	4,175	
W1	Overall Width (Shipping)	mm	3,440		
	Rear Swing Radius	mm	4,620		
H2	Ground Clearance	mm	*860		
L2	Rear End Distance	mm	4,565		
W2	House Width	mm	***3,410/4,450		
W3	Cabin Width	mm	1,010		
H3	Height Over Cover [Bonet]	mm	3,785		
H4	Counterweight Clearance	mm	*1,560/1,615		
H5	Track Height	mm	*1,350/1,405		
L3	Track Length	mm	6,341		
L4	Tumbler Distance	mm	5,100		
W5	Undercarriage Width [without step]	mm	***3,440/4,200		
	Undercarriage Width [with step]	mm	***3,732/4,492		
W6	Shoe Width	mm	650		
	Grouser Height	mm	52		

\* : Without Grouser

# WORKING RANGE

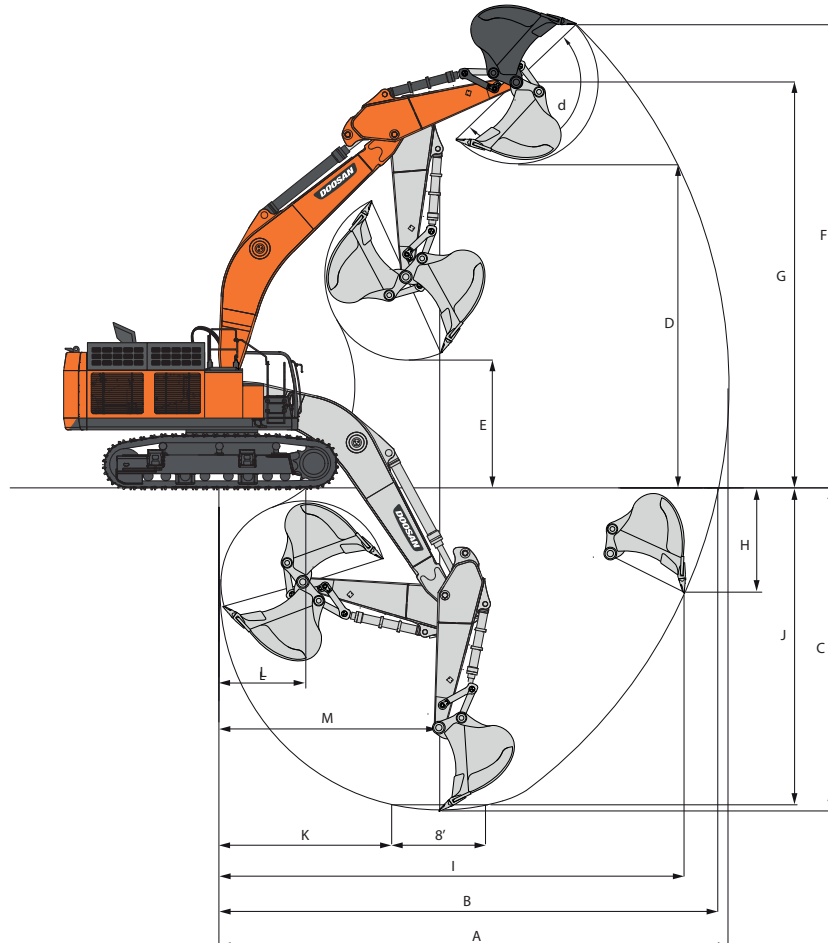

## WORKING RANGE

BOOM TYPE(ONE PIECE)		mm	7,250	8,400
ARM TYPE		mm	2,900	3,750
BUCKET TYPE		m <sup>3</sup>	6.8	5.4
A	MAX. DIGGING REACH	mm	12,430	14,275
B	MAX. DIGGING REACH (GROUND)	mm	12,110	14,000
C	MAX. DIGGING DEPTH	mm	7,260	8,795
D	MAX. LOADING HEIGHT	mm	8,100	9,440
E	MIN. LOADING HEIGHT	mm	3,910	4,210
F	MAX. DIGGING HEIGHT	mm	12,425	13,840
G	MAX. BUCKET PIN HEIGHT	mm	10,515	11,862
H	MAX. VERTICAL WALL DEPTH	mm	2,965	4,470
I	MAX. RADIUS VERTICAL	mm	10,995	12,265
J	MAX. DEPTH TO 8' LINE	mm	7,110	8,665
K	MIN. RADIUS 8' LINE	mm	4,410	5,290
L	MIN. DIGGING REACH	mm	1,970	3,365
M	MIN. SWING RADIUS	mm	5,345	6,295
d	BUCKET ANGLE	mm	145.3	143.8



# TRANSPORTATION

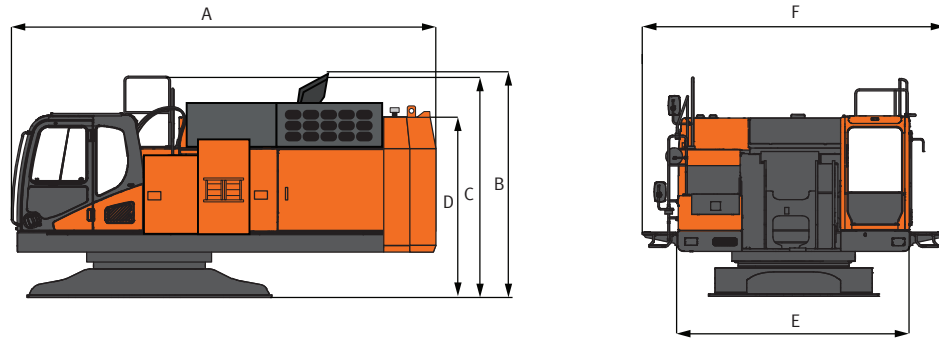

## UPPER STRUCTURE

Length	(mm)	A	6,282
Height (Top of Guardrail)	(mm)	B	3,280
Height (Top of Muffler)	(mm)	C	3,215
Height (Top of Cab)	(mm)	D	2,720
Width (Without Walkway)	(mm)	E	3,410
Width (With Walkway)	(mm)	F	4,450
Weight	(kg)	-	32,870

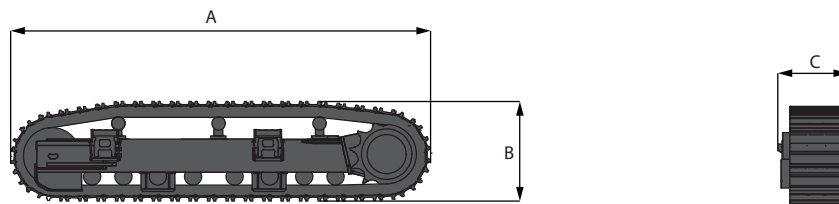

## UNDERCARRIAGE

Length	(mm)	A	6,370
Height	(mm)	B	1,455
Width (With Steps)	(mm)	C	1,185
Weight	(kg)	-	14,150

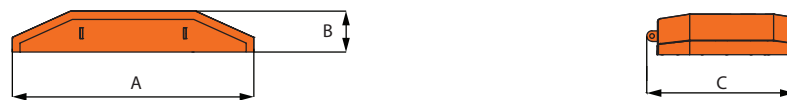

## COUNTERWEIGHT (STD)

Width	(mm)	A	4,450
Length	(mm)	B	730
Height	(mm)	C	2,119
Weight	(kg)	-	12,700



## COUNTERWEIGHT (Removal Opt.)

Width	(mm)	A	4,450
Length	(mm)	B	675
Height	(mm)	C	1,968
Weight	(kg)	-	11,300

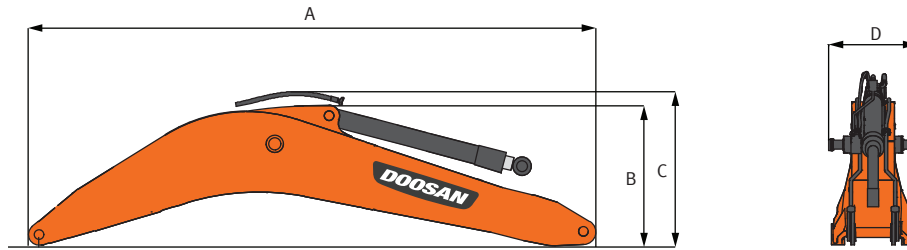

## BOOM

			8.4m	7.25m
Length	(mm)	A	8,805	7,640
Height (Top of Boom)	(mm)	B	2,220	2,465
Height (Top of Hoses)	(mm)	C	2,340	2,610
Width	(mm)	D	1,340	1,340
Weight	(mm)	-	10,740	10,230

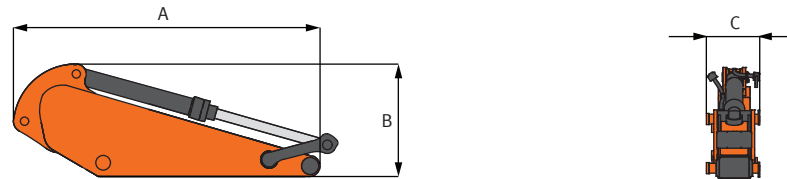

## ARM

			3.7m	2.9m
Length	(mm)	A	5,305	4,490
Height	(mm)	B	1,731	1,505
Width	(mm)	C	820	820
Weight	(mm)	-	5,825	5,590

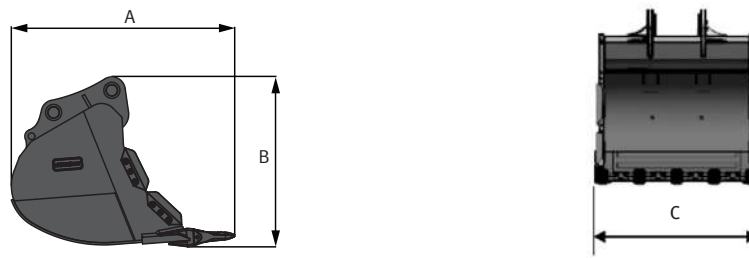

## BUCKET

			5.4m <sup>3</sup>	6.8m <sup>3</sup>
Length	(mm)	A	2,750	2,750
Height	(mm)	B	2,350	2,350
Width	(mm)	C	1,940	2,320



# LIFTING CAPACITY

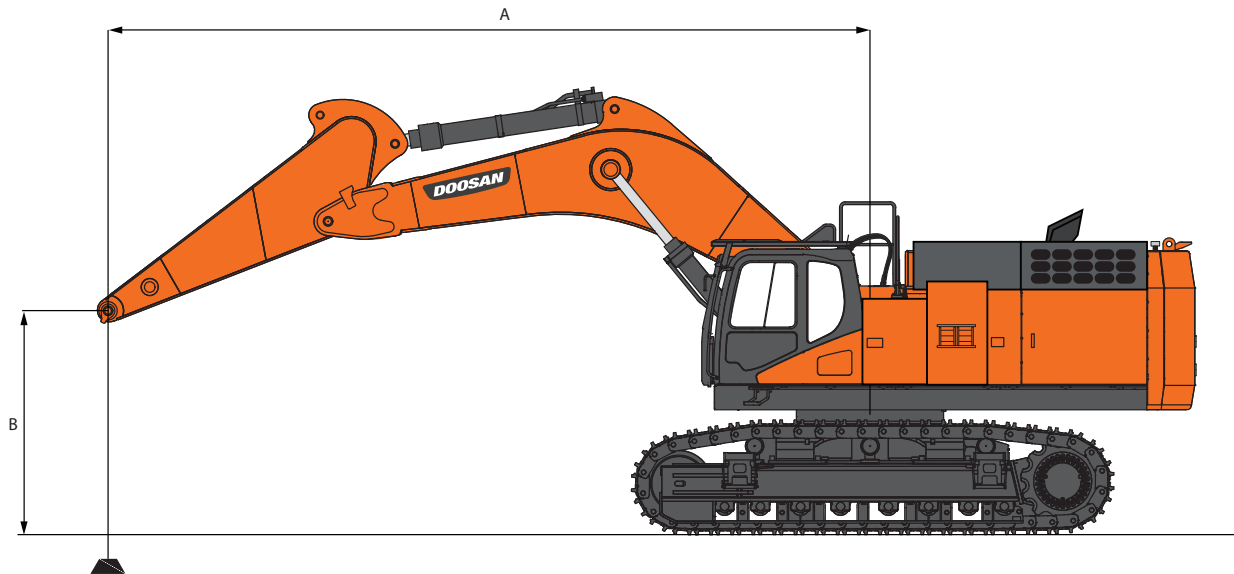

## STANDARD

### Metric

Boom: 7,250 mm (23'9") Arm: 2,900 mm (9'6") Shoe: 650 mm (2'1") Counter Weight: 12,760 kg (28,126lb)

A(m) \ B(m)	4.5		6		7.5		9		Max		Reach (m)
10.5									19.98 *	19.98 *	Max. at(m) 6.40
9					21.16 *	21.16 *			17.95 *	17.95 *	Max. at(m) 7.90
7.5					21.36 *	21.36 *			17.12 *	17.12 *	Max. at(m) 8.91
6 m			26.69 *	26.69 *	22.77 *	22.77 *	20.63 *	19.84	16.94 *	16.94 *	Max. at(m) 9.57
4.5 m			30.62 *	30.62 *	24.73 *	24.73 *	21.48 *	19.26	17.25 *	16.35	Max. at(m) 9.96
3 m			34.06 *	33.81	26.63 *	24.38	22.42 *	18.64	18.06 *	15.64	Max. at(m) 10.10
1.5 m			35.83 *	32.51	27.90 *	23.51	23.05 *	18.13	19.47 *	15.55	Max. at(m) 10.02
0 m			35.76 *	31.96	28.14 *	23.02	22.94 *	17.83	20.80 *	16.12	Max. at(m) 9.70
-1.5 m	43.15 *	43.15 *	34.02 *	31.92	27.04 *	22.91	21.42 *	17.87	20.89 *	17.57	Max. at(m) 9.13
-3 m	37.87 *	37.87 *	30.36 *	30.36 *	23.91 *	23.25			20.57 *	20.57	Max. at(m) 8.23
-4.5 m	29.38 *	29.38 *	23.41 *	23.41 *					19.02 *	19.02 *	Max. at(m) 6.89

### Feet

A(ft) \ B(ft)	15		20		25		30		Max		Reach (ft)
35 FT									44.04 *	44.04 *	Max. at(ft) 20.99
30 FT					46.64 *	46.64 *			39.57 *	39.57 *	Max. at(ft) 25.93
25 FT					47.08 *	47.08 *			37.73 *	37.73 *	Max. at(ft) 29.23
20 FT			58.84 *	58.84 *	50.20 *	50.20 *	45.49 *	43.74	37.34 *	37.34 *	Max. at(ft) 31.39
15 FT			67.52 *	67.52 *	54.52 *	54.52 *	47.36 *	42.46	38.04 *	36.05	Max. at(ft) 32.67
10 FT			75.09 *	74.54	58.71 *	53.75	49.44 *	41.09	39.82 *	34.47	Max. at(ft) 33.15
5 FT			78.99 *	71.68	61.50 *	51.83	50.81 *	39.96	42.92 *	34.27	Max. at(ft) 32.88
0 FT			78.84 *	70.45	62.03 *	50.74	50.58 *	39.31	45.86 *	35.53	Max. at(ft) 31.84
-5 FT	95.13 *	95.13 *	75.00 *	70.37	59.61 *	50.51	47.22 *	39.41	46.06 *	38.74	Max. at(ft) 29.94
-10 FT	83.49 *	83.49 *	66.93 *	66.93 *	52.71 *	51.25			45.35 *	45.34	Max. at(ft) 27.00
-15 FT	64.78 *	64.78 *	51.60 *	51.60 *					41.92 *	41.92 *	Max. at(ft) 22.61











1. Load point is the end of the arm.
2. Capacities marked with an asterisk (\*) are limited by hydraulic capacities.
3. Lift capacities shown do not exceed 75 % of minimum tipping loads or 87 % of hydraulic capacities.
4. The least stable position is over the side.
5. Lift capacities apply only to the machine as originally manufactured and normally equipped by the manufacturer.
6. The total mass of machine is 91,025 kg included in this mass boom 7.25 m, arm 2.9 m, 12,758 kg counterweight, 6.8 Kg bucket, all operating fluids and a 75 kg operator.
7. Lift capacities are in compliance with ISO 10567.

: Rating Over Front  
 : Rating Over Side or 360 Degree











## OPTION 1

### Metric

Boom: 7,250 mm (23'9") Arm: 2,900 mm (9'6") Shoe: 750 mm (2'4") Counter Weight: 12,760 kg (28,126lb)

A(m) B(m)	4.5		6		7.5		9		Max		Reach (m)
											
10.5									19.98 *	19.98 *	Max. at(m) 6.40
9					21.16 *	21.16 *			17.95 *	17.95 *	Max. at(m) 7.90
7.5					21.36 *	21.36 *			17.12 *	17.12 *	Max. at(m) 8.91
6			26.69 *	26.69 *	22.77 *	22.77 *	20.63 *	19.96	16.94 *	16.94 *	Max. at(m) 9.57
4.5			30.62 *	30.62 *	24.73 *	24.73 *	21.48 *	19.39	17.25 *	16.46	Max. at(m) 9.96
3			34.06 *	34.03	26.63 *	24.54	22.42 *	18.76	18.06 *	15.74	Max. at(m) 10.10
1.5			35.83 *	32.73	27.90 *	23.67	23.05 *	18.25	19.47 *	15.65	Max. at(m) 10.02
0			35.76 *	32.17	28.14 *	23.17	22.94 *	17.96	20.80 *	16.23	Max. at(m) 9.70
-1.5	43.15 *	43.15 *	34.02 *	32.13	27.04 *	23.07	21.42 *	18	20.89 *	17.69	Max. at(m) 9.13
-3	37.87 *	37.87 *	30.36 *	30.36 *	23.91 *	23.4			20.57 *	20.57 *	Max. at(m) 8.23
-4.5	29.38 *	29.38 *	23.41 *	23.41 *					19.02 *	19.02 *	Max. at(m) 6.89

### Feet

A(ft) B(ft)	15		20		25		30		Max		Reach (ft)
											
35									44.04 *	44.04 *	Max. at(ft) 20.99
30					46.64 *	46.64 *			39.57 *	39.57 *	Max. at(ft) 25.93
25					47.08 *	47.08 *			37.73 *	37.73 *	Max. at(ft) 29.23
20			58.84 *	58.84 *	50.20 *	50.20 *	45.49 *	44.01	37.34 *	37.34 *	Max. at(ft) 31.39
15			67.52 *	67.52 *	54.52 *	54.52 *	47.36 *	42.74	38.04 *	36.29	Max. at(ft) 32.67
10			75.09 *	75.01	58.71 *	54.1	49.44 *	41.36	39.82 *	34.71	Max. at(ft) 33.15
5			78.99 *	72.15	61.50 *	52.18	50.81 *	40.23	42.92 *	34.51	Max. at(ft) 32.88
0			78.84 *	70.92	62.03 *	51.09	50.58 *	39.59	45.86 *	35.78	Max. at(ft) 31.84
-5	95.13 *	95.13 *	75.00 *	70.84	59.61 *	50.85	47.22 *	39.68	46.06 *	39.01	Max. at(ft) 29.94
-10	83.49 *	83.49 *	66.93 *	66.93 *	52.71 *	51.6			45.35 *	45.35 *	Max. at(ft) 27.00
-15	64.78 *	64.78 *	51.60 *	51.60 *					41.92 *	41.92 *	Max. at(ft) 22.61

- Load point is the end of the arm.
- Capacities marked with an asterisk (\*) are limited by hydraulic capacities.
- Lift capacities shown do not exceed 75 % of minimum tipping loads or 87 % of hydraulic capacities.
- The least stable position is over the side.
- Lift capacities apply only to the machine as originally manufactured and normally equipped by the manufacturer.
- The total mass of machine is 91,637 kg included in this mass boom 7.25 m, arm 2.9 m, 12,758 kg counterweight, 6.8 Kg bucket, all operating fluids and a 75 kg operator.
- Lift capacities are in compliance with ISO 10567.

 : Rating Over Front













 : Rating Over Side or 360 Degree

# LIFTING CAPACITY













## OPTION 2

### Metric



Boom: 8,400 mm (27'6") Arm: 3,700 mm (12'1") Shoe: 750 mm (2'4") Counter Weight: 12,760 kg (28,126lb)

A(m) B(m)	4.5		6		7.5		9		10.5		Max		Reach (m)
													
10.5							15.25 *	15.25 *			14.63 *	14.63 *	Max. at(m) 9.06
9							17.95 *	17.95 *			13.90 *	13.90 *	Max. at(m) 10.17
7.5					20.71 *	20.71 *	18.47 *	18.47 *	17.01 *	15.53	13.63 *	13.63 *	Max. at(m) 10.96
6					22.52 *	22.52 *	19.41 *	19.41 *	17.35 *	15.18	13.67 *	12.87	Max. at(m) 11.50
4.5					24.49 *	24.49 *	20.48 *	18.75	17.86 *	14.69	14.00 *	12	Max. at(m) 11.83
3					26.09 *	23.34	21.41 *	17.91	18.30 *	14.19	14.64 *	11.53	Max. at(m) 11.95
1.5					26.88 *	22.31	21.92 *	17.22	18.47 *	13.76	15.63 *	11.42	Max. at(m) 11.88
0					26.68 *	21.71	21.80 *	16.76	18.16 *	13.46	15.67 *	11.67	Max. at(m) 11.62
-1.5			31.29 *	30.12	25.46 *	21.48	20.88 *	16.55	17.09 *	13.36	15.37 *	12.36	Max. at(m) 11.14
-3	33.04 *	33.04 *	28.04 *	28.04 *	23.16 *	21.56	18.91 *	16.61			14.81 *	13.68	Max. at(m) 10.43
-4.5	27.13 *	27.13 *	23.42 *	23.42 *	19.41 *	19.41 *	15.18 *	15.18 *			13.70 *	13.70 *	Max. at(m) 9.41
-6			16.64 *	16.64 *	13.05 *	13.05 *					11.34 *	11.34 *	Max. at(m) 7.98

### Feet

A(ft) B(ft)	15		20		25		30		35		Max		Reach (ft)
													
35							33.63 *	33.63 *			32.26 *	32.26 *	Max. at(ft) 29.72
30							39.57 *	39.57 *			30.65 *	30.65 *	Max. at(ft) 33.37
25					45.66 *	45.66 *	40.71 *	40.71 *	37.49 *	34.25	30.04 *	30.04 *	Max. at(ft) 35.97
20					49.64 *	49.64 *	42.78 *	42.78 *	38.25 *	33.47	30.14 *	28.38	Max. at(ft) 37.74
15					53.99 *	53.99 *	45.16 *	41.33	39.37 *	32.39	30.87 *	26.45	Max. at(ft) 38.80
10					57.52 *	51.45	47.20 *	39.47	40.35 *	31.28	32.26 *	25.43	Max. at(ft) 39.21
5					59.26 *	49.19	48.32 *	37.96	40.72 *	30.33	34.47 *	25.18	Max. at(ft) 38.98
0					58.82 *	47.86	48.06 *	36.94	40.04 *	29.68	34.55 *	25.74	Max. at(ft) 38.11
-5			68.99 *	66.39	56.14 *	47.35	46.04 *	36.49	37.68 *	29.46	33.88 *	27.26	Max. at(ft) 36.55
-10	72.85 *	72.85 *	61.82 *	61.82 *	51.05 *	47.54	41.69 *	36.62			32.66 *	30.16	Max. at(ft) 34.20
-15	59.81 *	59.81 *	51.64 *	51.64 *	42.80 *	42.80 *	33.46 *	33.46 *			30.21 *	30.21 *	Max. at(ft) 30.86
-20			36.68 *	36.68 *	28.77 *	28.77 *					25.01 *	25.01 *	Max. at(ft) 26.19

1. Load point is the end of the arm.
2. Capacities marked with an asterisk (\*) are limited by hydraulic capacities.
3. Lift capacities shown do not exceed 75 % of minimum tipping loads or 87 % of hydraulic capacities.
4. The least stable position is over the side.
5. Lift capacities apply only to the machine as originally manufactured and normally equipped by the manufacturer.
6. The total mass of machine is 92,521 kg included in this mass boom 8.4 m, arm 3.7 m, 12758 kg counterweight, 5.4 Kg bucket, all operating fluids and a 75 kg operator.
7. Lift capacities are in compliance with ISO 10567.













 : Rating Over Front  
 : Rating Over Side or 360 Degree















### OPTION 3

#### Metric



Boom: 8,400 mm (27'6") Arm: 3,700 mm (12'1") Shoe: 900 mm (2'9") Counter Weight: 12,760 kg (28,126lb)

A(m) B(m)	4.5		6		7.5		9		10.5		Max		Reach (m)
													
10.5							15.25 *	15.25 *			14.63 *	14.63 *	Max. at(m) 9.06
9							17.95 *	17.95 *			13.90 *	13.90 *	Max. at(m) 10.17
7.5					20.71 *	20.71 *	18.47 *	18.47 *	17.01 *	15.73	13.63 *	13.63 *	Max. at(m) 10.96
6					22.52 *	22.52 *	19.41 *	19.41 *	17.35 *	15.38	13.67 *	13.05	Max. at(m) 11.50
4.5					24.49 *	24.49 *	20.48 *	18.99	17.86 *	14.89	14.00 *	12.17	Max. at(m) 11.83
3					26.09 *	23.64	21.41 *	18.15	18.30 *	14.39	14.64 *	11.7	Max. at(m) 11.95
1.5					26.88 *	22.62	21.92 *	17.46	18.47 *	13.96	15.63 *	11.6	Max. at(m) 11.88
0					26.68 *	22.01	21.80 *	17	18.16 *	13.66	15.67 *	11.85	Max. at(m) 11.62
-1.5			31.29 *	30.53	25.46 *	21.78	20.88 *	16.79	17.09 *	13.56	15.37 *	12.55	Max. at(m) 11.14
-3	33.04 *	33.04 *	28.04 *	28.04 *	23.16 *	21.87	18.91 *	16.85			14.81 *	13.88	Max. at(m) 10.43
-4.5	27.13 *	27.13 *	23.42 *	23.42 *	19.41 *	19.41 *	15.18 *	15.18 *			13.70 *	13.70 *	Max. at(m) 9.41
-6			16.64 *	16.64 *	13.05 *	13.05 *					11.34 *	11.34 *	Max. at(m) 7.98

#### Feet

A(ft) B(ft)	15		20		25		30		35		Max		Reach (ft)
													
35							33.63 *	33.63 *			32.26 *	32.26 *	Max. at(ft) 29.72
30							39.57 *	39.57 *			30.65 *	30.65 *	Max. at(ft) 33.37
25					45.66 *	45.66 *	40.71 *	40.71 *	37.49 *	34.69	30.04 *	30.04 *	Max. at(ft) 35.97
20					49.64 *	49.64 *	42.78 *	42.78 *	38.25 *	33.91	30.14 *	28.77	Max. at(ft) 37.74
15					53.99 *	53.99 *	45.16 *	41.86	39.37 *	32.83	30.87 *	26.84	Max. at(ft) 38.80
10					57.52 *	52.12	47.20 *	40.01	40.35 *	31.72	32.26 *	25.8	Max. at(ft) 39.21
5					59.26 *	49.86	48.32 *	38.49	40.72 *	30.77	34.47 *	25.56	Max. at(ft) 38.98
0					58.82 *	48.53	48.06 *	37.48	40.04 *	30.12	34.55 *	26.13	Max. at(ft) 38.11
-5			68.99 *	67.31	56.14 *	48.02	46.04 *	37.02	37.68 *	29.9	33.88 *	27.66	Max. at(ft) 36.55
-10	72.85 *	72.85 *	61.82 *	61.82 *	51.05 *	48.21	41.69 *	37.16			32.66 *	30.6	Max. at(ft) 34.20
-15	59.81 *	59.81 *	51.64 *	51.64 *	42.80 *	42.80 *	33.46 *	33.46 *			30.21 *	30.21 *	Max. at(ft) 30.86
-20			36.68 *	36.68 *	28.77 *	28.77 *					25.01 *	25.01 *	Max. at(ft) 26.19

1. Load point is the end of the arm.
2. Capacities marked with an asterisk (\*) are limited by hydraulic capacities.
3. Lift capacities shown do not exceed 75 % of minimum tipping loads or 87 % of hydraulic capacities.
4. The least stable position is over the side.
5. Lift capacities apply only to the machine as originally manufactured and normally equipped by the manufacturer.
6. The total mass of machine is 93,714 kg included in this mass boom 8.4 m, arm 3.7 m, 12758 kg counterweight, 5.4 Kg bucket, all operating fluids and a 75 kg operator.
7. Lift capacities are in compliance with ISO 10567.

 : Rating Over Front  
 : Rating Over Side or 360 Degree

# STANDARD & OPTION

## STANDARD EQUIPMENT

### Hydraulic system

---

- Boom and arm flow regeneration
- Boom and arm holding valves
- Swing anti-rebound valves
- Spare ports (Control valve)

### Cabin & Interior

---

- Viscous cab mounts
- All weather sound suppressed type cab
- Air conditioner & Heater
- Adjustable suspension seat with head rest and adjustable arm rest
- Pull-up type front window and removable lower front window
- Room light
- Intermittent windshield wiper
- Cigarette lighter and ashtray
- Cup holder
- Hot & Cool box
- LCD color monitor panel
- E/G RPM control dial
- AM/FM radio + MP3 (USB)
- Remote radio ON/OFF switch
- 12V spare powers socket
- Serial communication port for laptop PC interface
- Joystick lever with 3 switches
- Sun visor
- Sun roof

### Safety

---

- Large handrails and step
- Convex metal anti-slip plates
- Seat belt
- Hydraulic safety lock lever
- Safety glass
- Hammer for emergency escape
- Right and left rearview mirrors
- Battery protector cover

### Others

---

- Double element air cleaner with two stage filtration
- Water separator
- Fuel filter
- Dust screen for radiator/oil cooler
- Engine overheat prevention system
- Engine restart prevention system
- Self-diagnostic system
- Alternator (24 V, 115 A)
- Electric horn
- LED working lights (boom mounted 2, frame mounted 2, storage box mounted 1)
- Hydraulic track adjuster
- Track guards
- Greased and sealed track link
- Hydraulic oil tank air breather filter

## OPTIONAL EQUIPMENT

Some of optional equipments may be standard in some markets. Some of this optional equipment is not available in some markets. You must check with the local DOOSAN dealer to know about the availability or to release the adaptation following the needs of the applications

<b>Arm</b> <ul style="list-style-type: none"> <li>• 2.9 m Arm</li> <li>• 3.75 m Arm</li> </ul>	<b>Lever Pattern Change</b> <ul style="list-style-type: none"> <li>• Lever Pattern Change</li> </ul>	<b>Additional Work Lamp</b> <ul style="list-style-type: none"> <li>• 2 Additional Working Lamp(LED)</li> <li>• 6 Additional Working Lamp(LED)</li> </ul>
<b>Boom</b> <ul style="list-style-type: none"> <li>• 8.4 m Boom</li> <li>• 7.25 m Boom</li> </ul>	<b>One &amp; Two Way Front Piping</b> <ul style="list-style-type: none"> <li>• One &amp; Two Way Front Piping</li> </ul>	<b>Lower Wiper</b> <ul style="list-style-type: none"> <li>• Lower Wiper</li> </ul>
<b>Bucket (SAE/PSCA)</b> <ul style="list-style-type: none"> <li>• 5.4 m<sup>3</sup> S Class Bucket</li> <li>• 6.8 m<sup>3</sup> S Class Bucket</li> <li>• Only Dummy Link No Bucket</li> </ul>	<b>Rotating Piping(PERO)</b> <ul style="list-style-type: none"> <li>• Rotating Piping(PERO)</li> </ul>	<b>Overload Warning Device</b> <ul style="list-style-type: none"> <li>• Overload Warning Device</li> </ul>
<b>Boom Cylinder Guard</b> <ul style="list-style-type: none"> <li>• Boom Cylinder Guard</li> </ul>	<b>One &amp; Two Way Piping</b> <ul style="list-style-type: none"> <li>• Mono Two Way with Pedal</li> <li>• Mono Two Way without Pedal</li> <li>• Mono One Way with Electric Ped</li> <li>• Mono One Way</li> </ul>	<b>Rotating Beacon</b> <ul style="list-style-type: none"> <li>• Rotating Beacon</li> </ul>
<b>Bucket Cylinder Guard</b> <ul style="list-style-type: none"> <li>• Bucket Cylinder Guard</li> </ul>	<b>Quick Coupler Piping</b> <ul style="list-style-type: none"> <li>• Quick Coupler Piping</li> </ul>	<b>Cabin Roof Cover</b> <ul style="list-style-type: none"> <li>• Plastic Roof Cover</li> <li>• Steel Roof Cover</li> </ul>
<b>Track Guard</b> <ul style="list-style-type: none"> <li>• 650 mm Double Grouser Shoe</li> <li>• 750 mm Double Grouser Shoe</li> <li>• 900 mm Double Grouser Shoe</li> </ul>	<b>Straight Travel</b> <ul style="list-style-type: none"> <li>• Straight Travel</li> </ul>	<b>Water Separator With Heater</b> <ul style="list-style-type: none"> <li>• Water Separator with Heater</li> <li>• Water Separator without Heater</li> </ul>
<b>Breaker Filter</b> <ul style="list-style-type: none"> <li>• Breaker Filter</li> </ul>	<b>Two Pumps &amp; Piping</b> <ul style="list-style-type: none"> <li>• Two Pumps</li> </ul>	<b>Telematics</b> <ul style="list-style-type: none"> <li>• 1.5 Global Dual (SAT+Cell)</li> <li>• 2.0 CHINA (Cell only)</li> <li>• 2.0 Global (Cell only)</li> <li>• 2.0 Global Dual(SAT+Cell)</li> </ul>
<b>Hydraulic Oil</b> <ul style="list-style-type: none"> <li>• Cold Weather (VG32)</li> <li>• Normal Weather (VG46)</li> <li>• Tropical Weather (VG68)</li> </ul>	<b>Audio Equipment</b> <ul style="list-style-type: none"> <li>• Radio+MP3(Stereo)</li> </ul>	<b>Air Compressor</b> <ul style="list-style-type: none"> <li>• Air Compressor</li> </ul>
<b>FOGS Guard</b> <ul style="list-style-type: none"> <li>• FOGS</li> <li>• Top Guard</li> </ul>	<b>Rain Shield</b> <ul style="list-style-type: none"> <li>• Rain Shield</li> </ul>	<b>Auto Greasing Unit</b> <ul style="list-style-type: none"> <li>• Auto Greasing Unit</li> </ul>
<b>Mirror</b> <ul style="list-style-type: none"> <li>• Side Mirror</li> </ul>	<b>Alarm</b> <ul style="list-style-type: none"> <li>• Alarm for Travel and Swing</li> </ul>	<b>Additional Mirror</b> <ul style="list-style-type: none"> <li>• Additional Mirror</li> </ul>
	<b>Camera</b> <ul style="list-style-type: none"> <li>• Around View Camera</li> <li>• Rear View Camera</li> </ul>	<b>Fuel Filler Pump</b> <ul style="list-style-type: none"> <li>• Fuel Filler Pump</li> </ul>
	<b>Cabin Front Guard</b> <ul style="list-style-type: none"> <li>• Upper and Lower Guard</li> <li>• Lower Guard Only</li> </ul>	
	<b>Under Cover</b> <ul style="list-style-type: none"> <li>• Standard Under Cover</li> </ul>	

\*Above option list could be changed without notice